

1

Parker Solar Probe Toy Brick Model

Designed for the Applied Physics Lab (APL) at Johns Hopkins University (JHU)

December 2023

Designed by FIRST Robotics Team 2614 (Team MARS - Mountaineer Area Robotics)

2

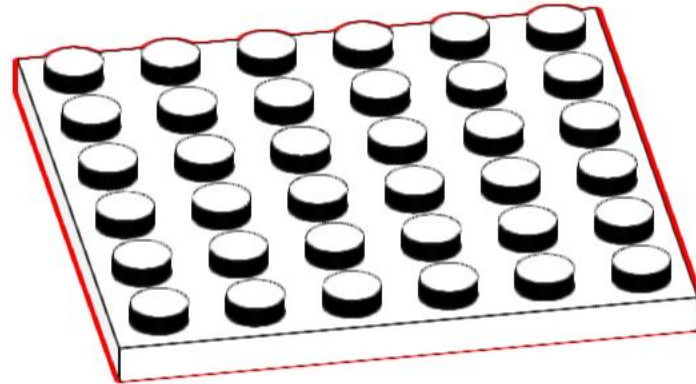
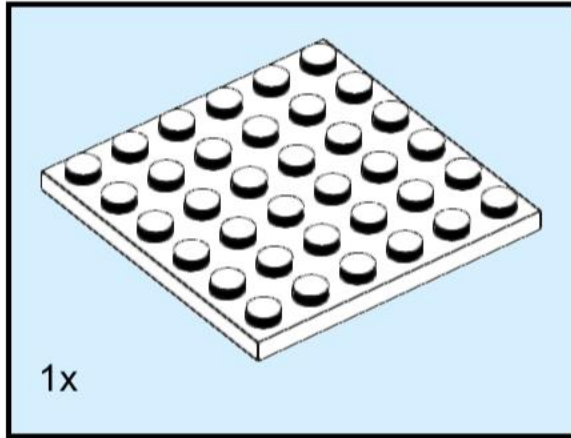

3

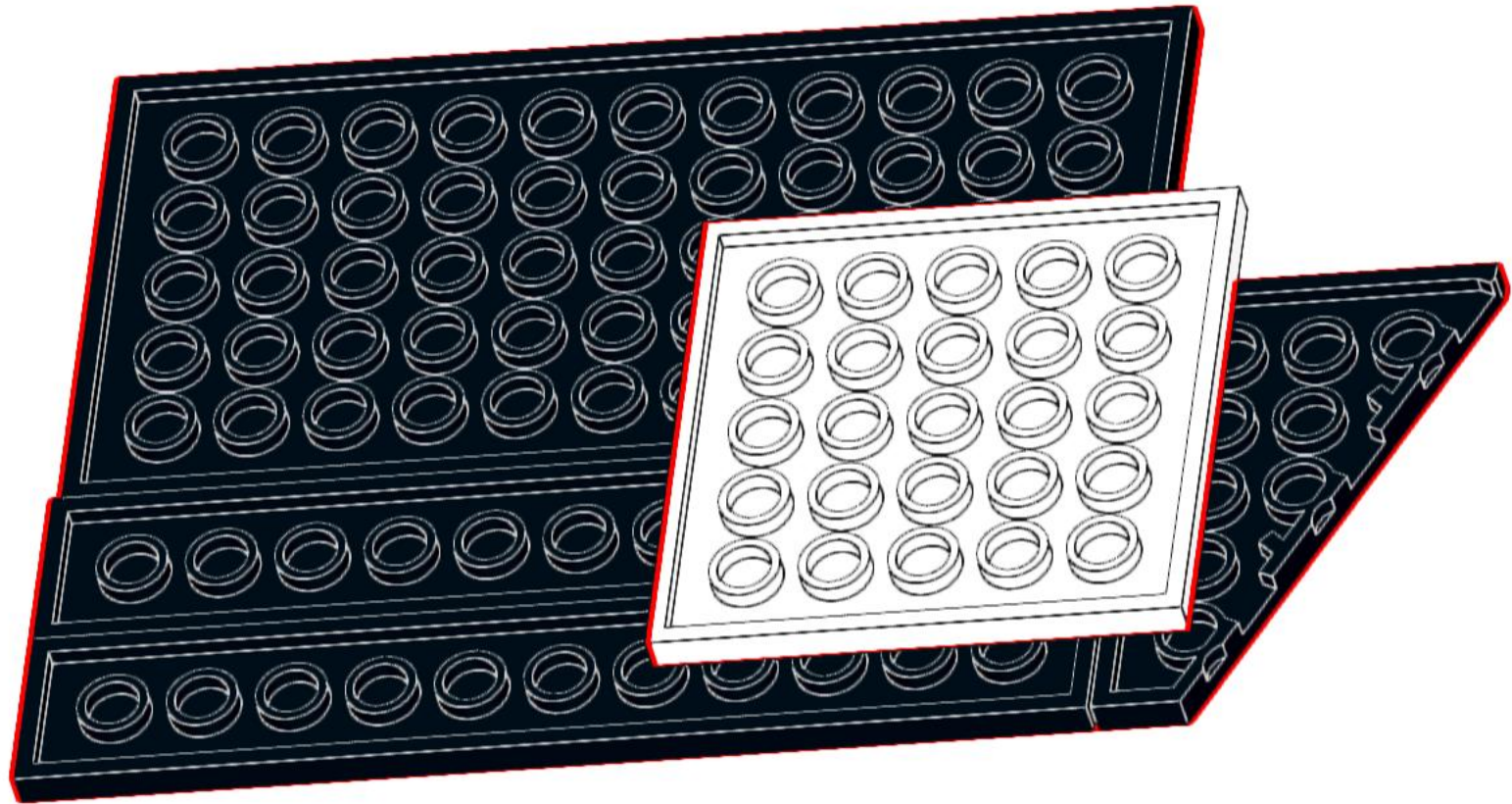
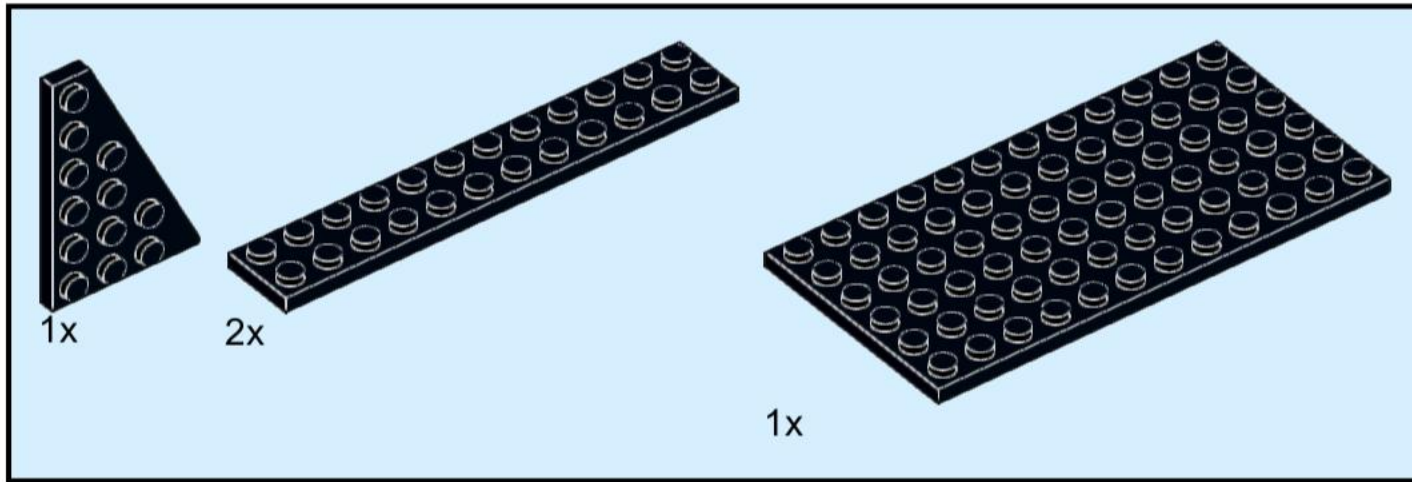

4

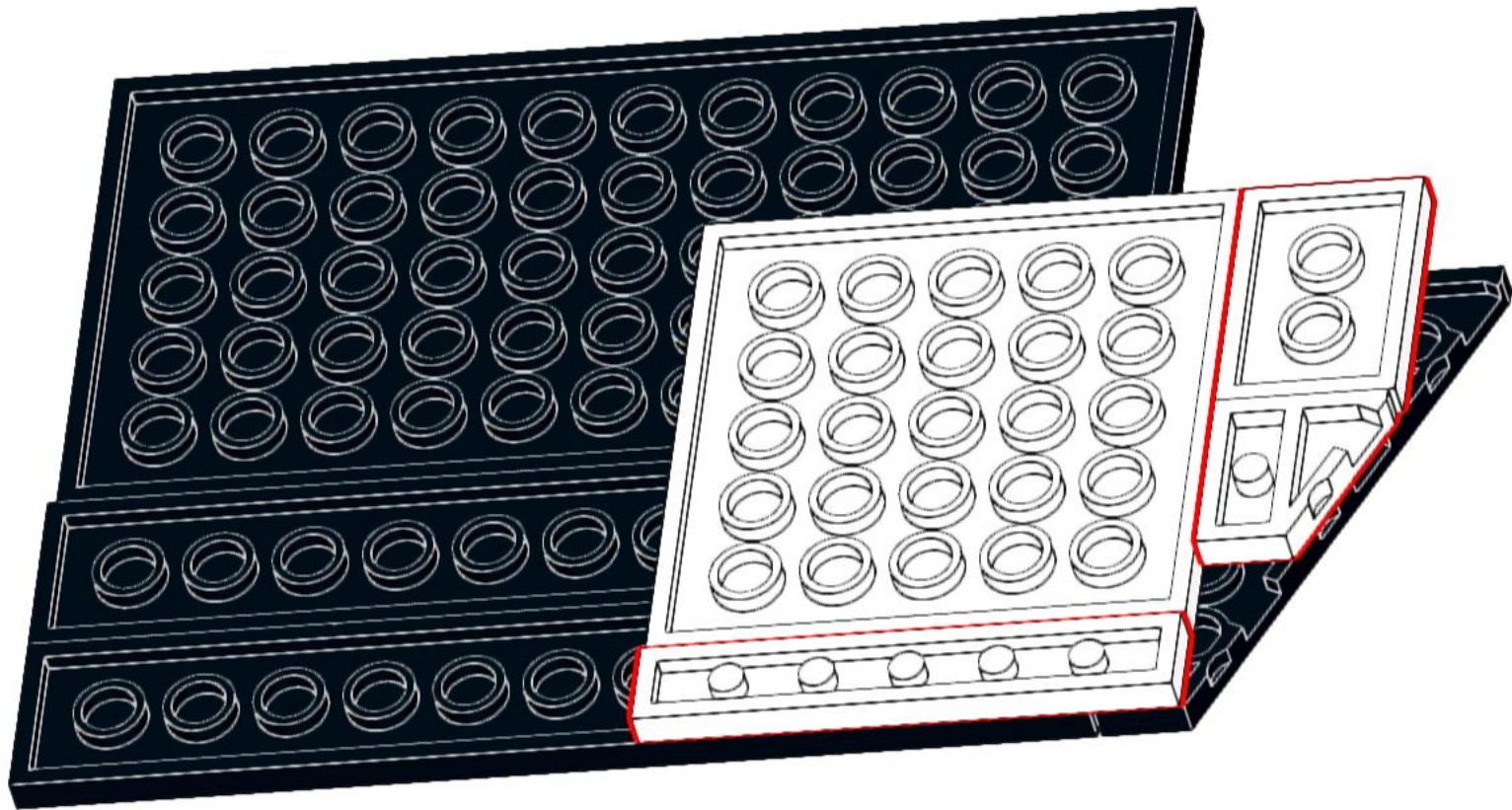
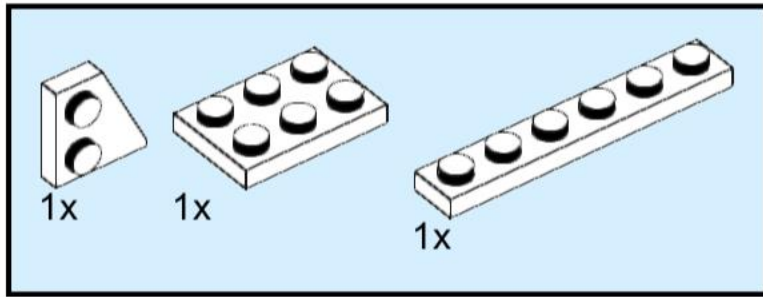

5

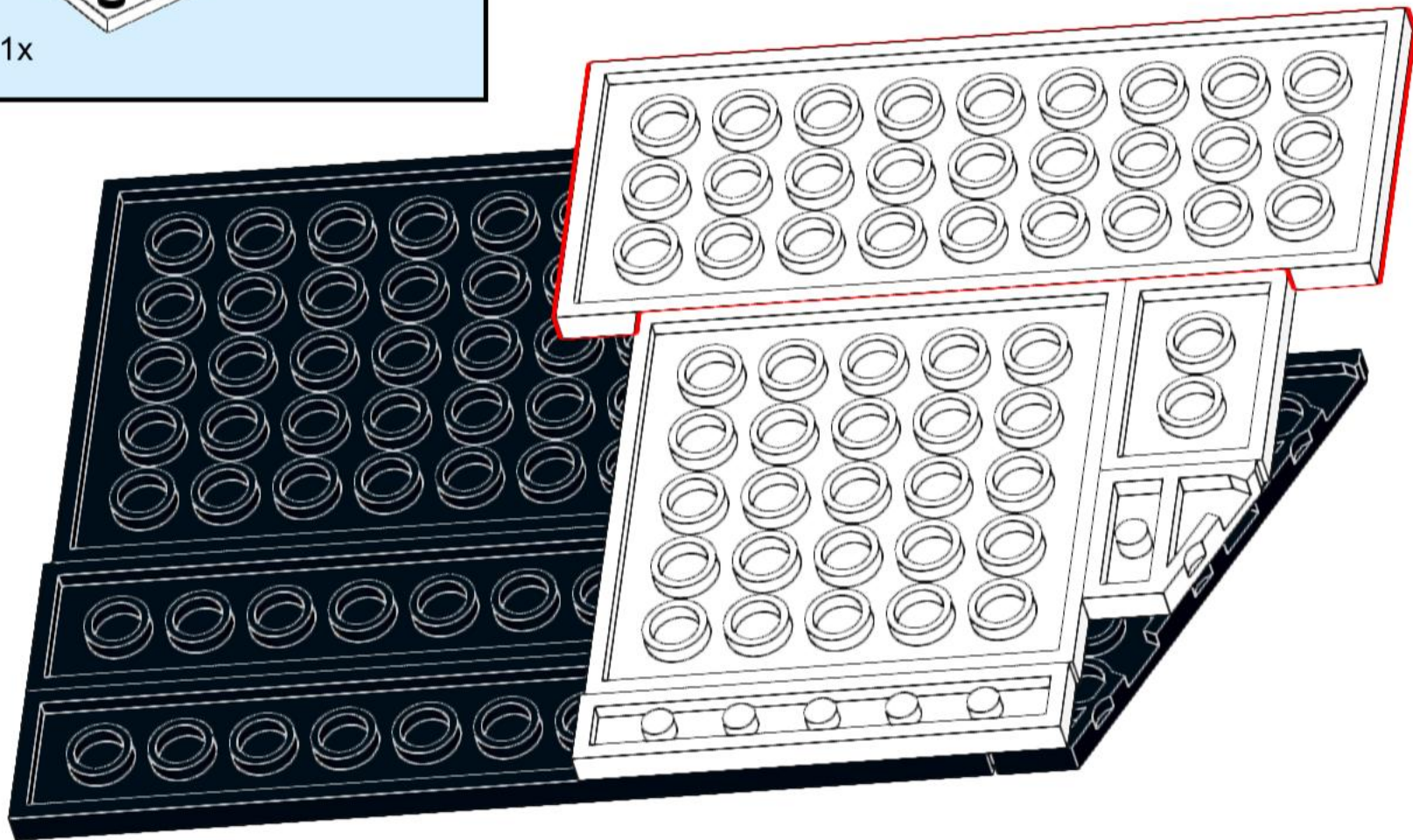
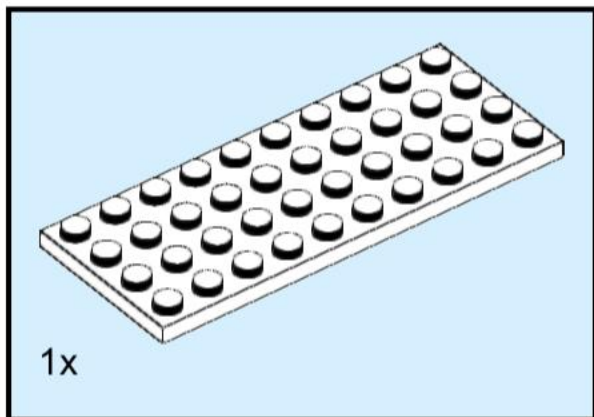

6

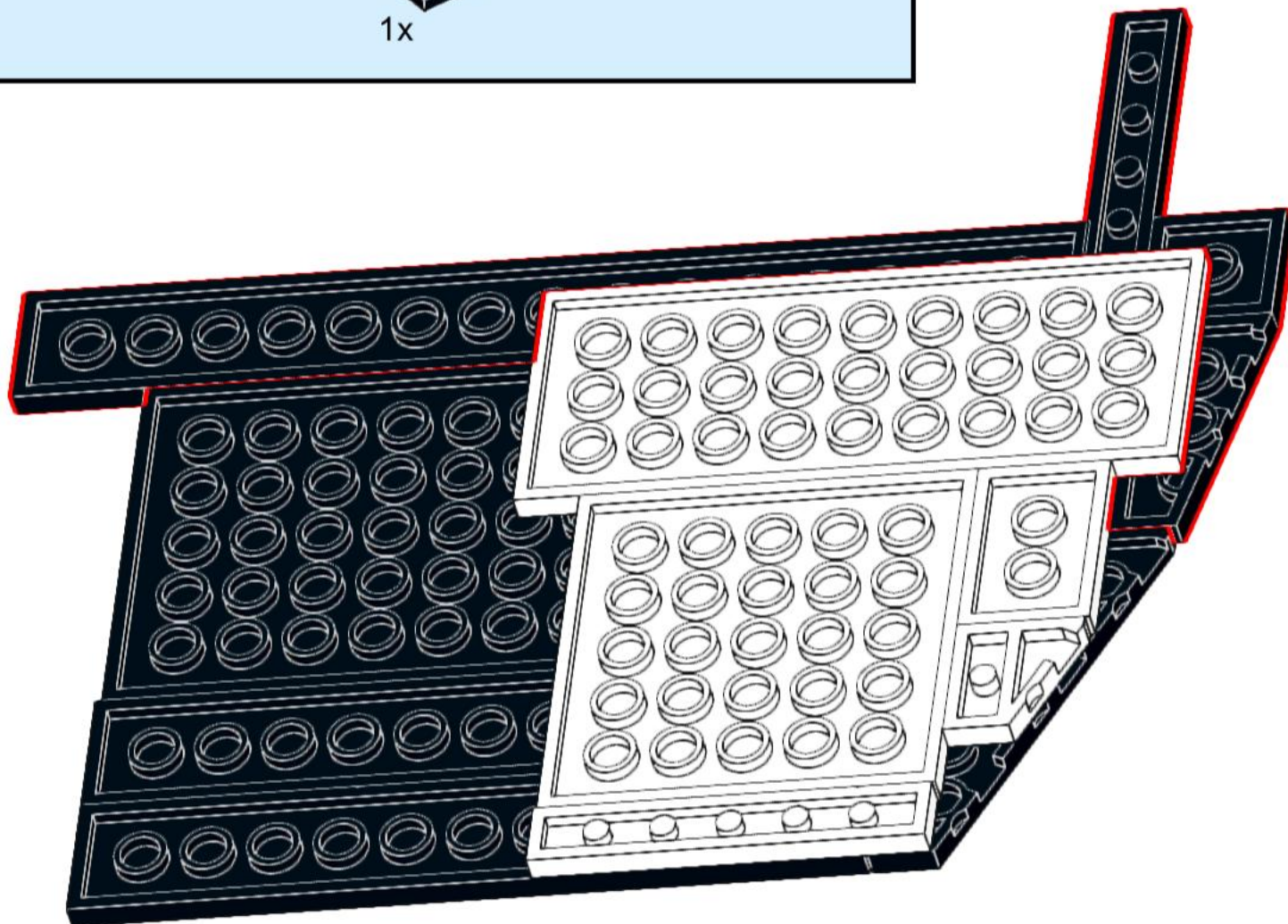
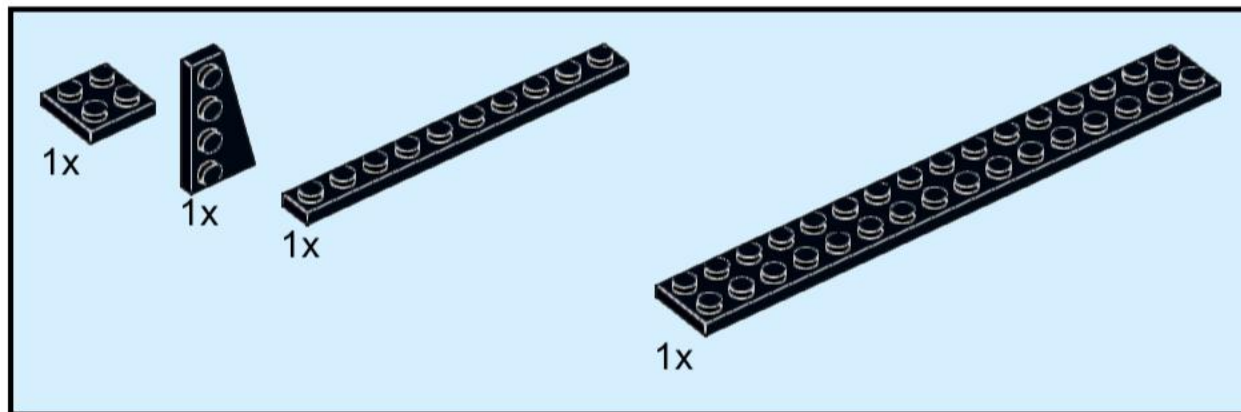

7

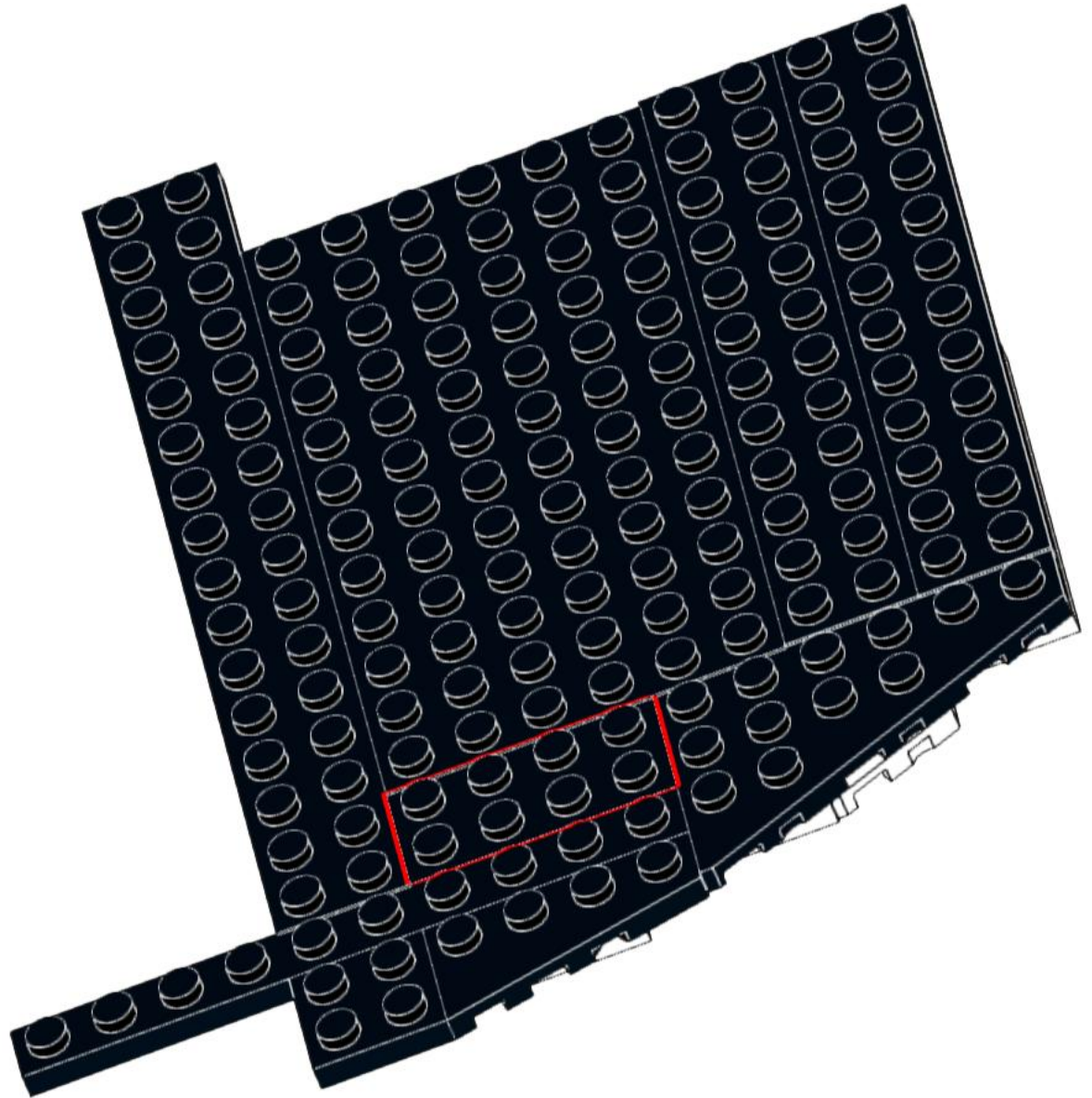
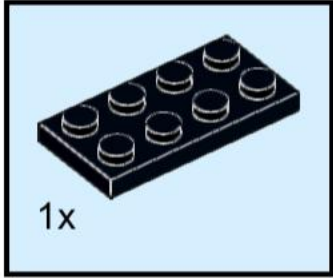

8

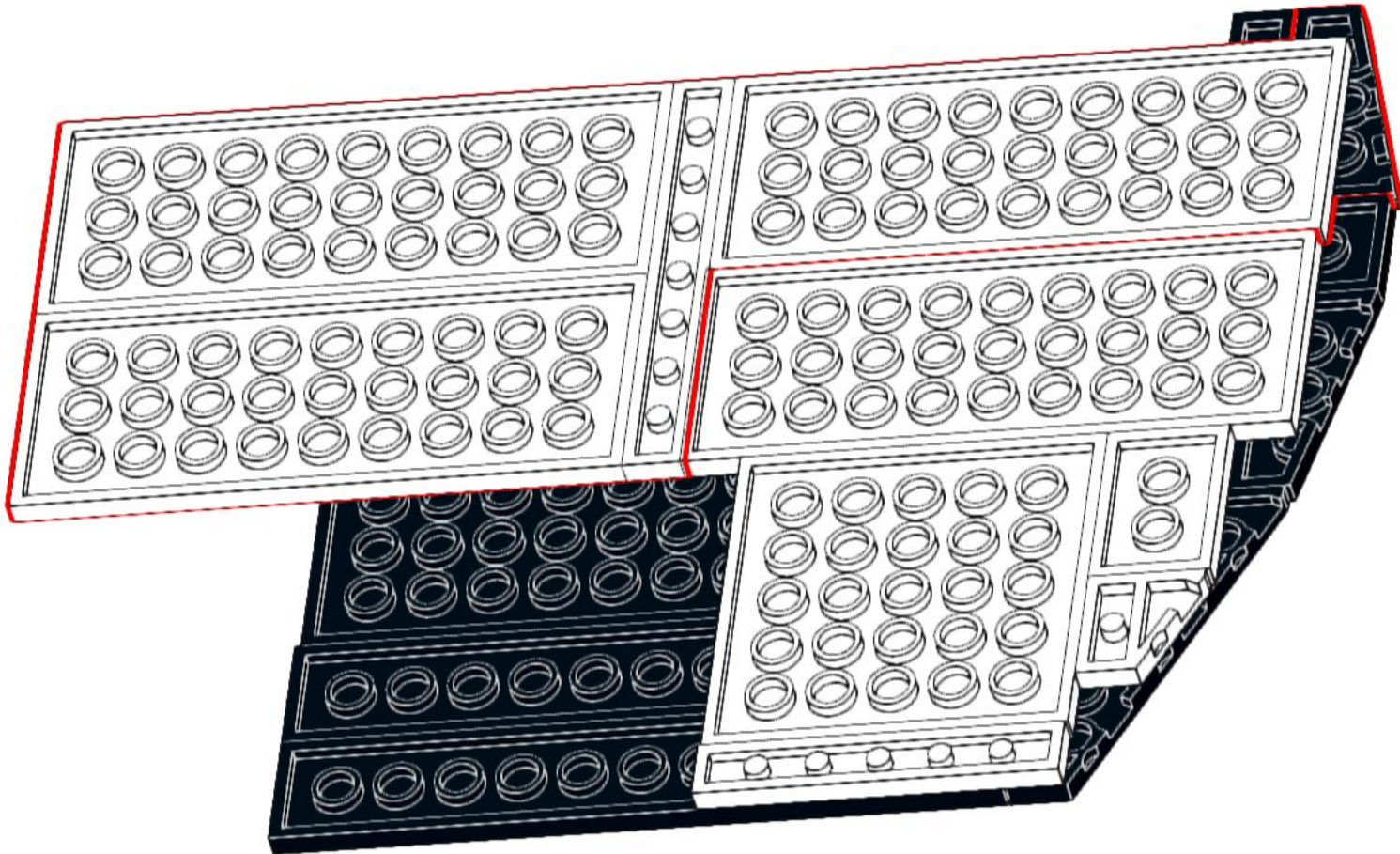
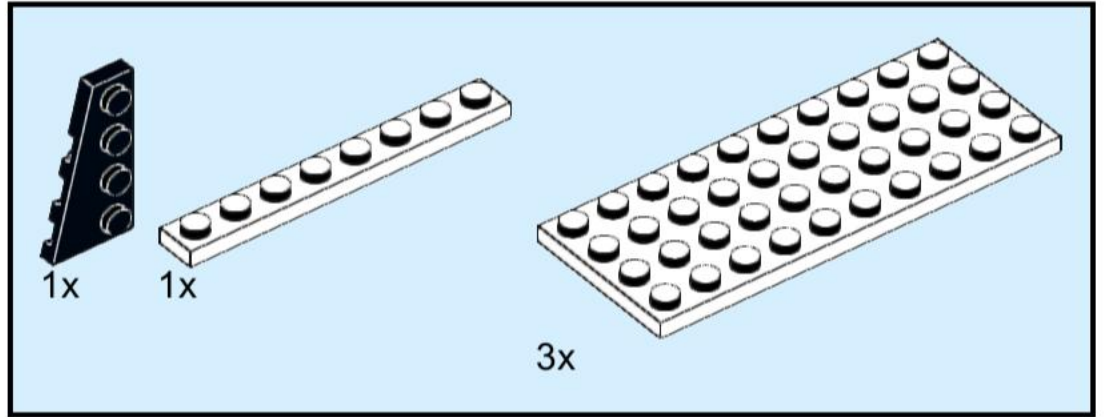

9

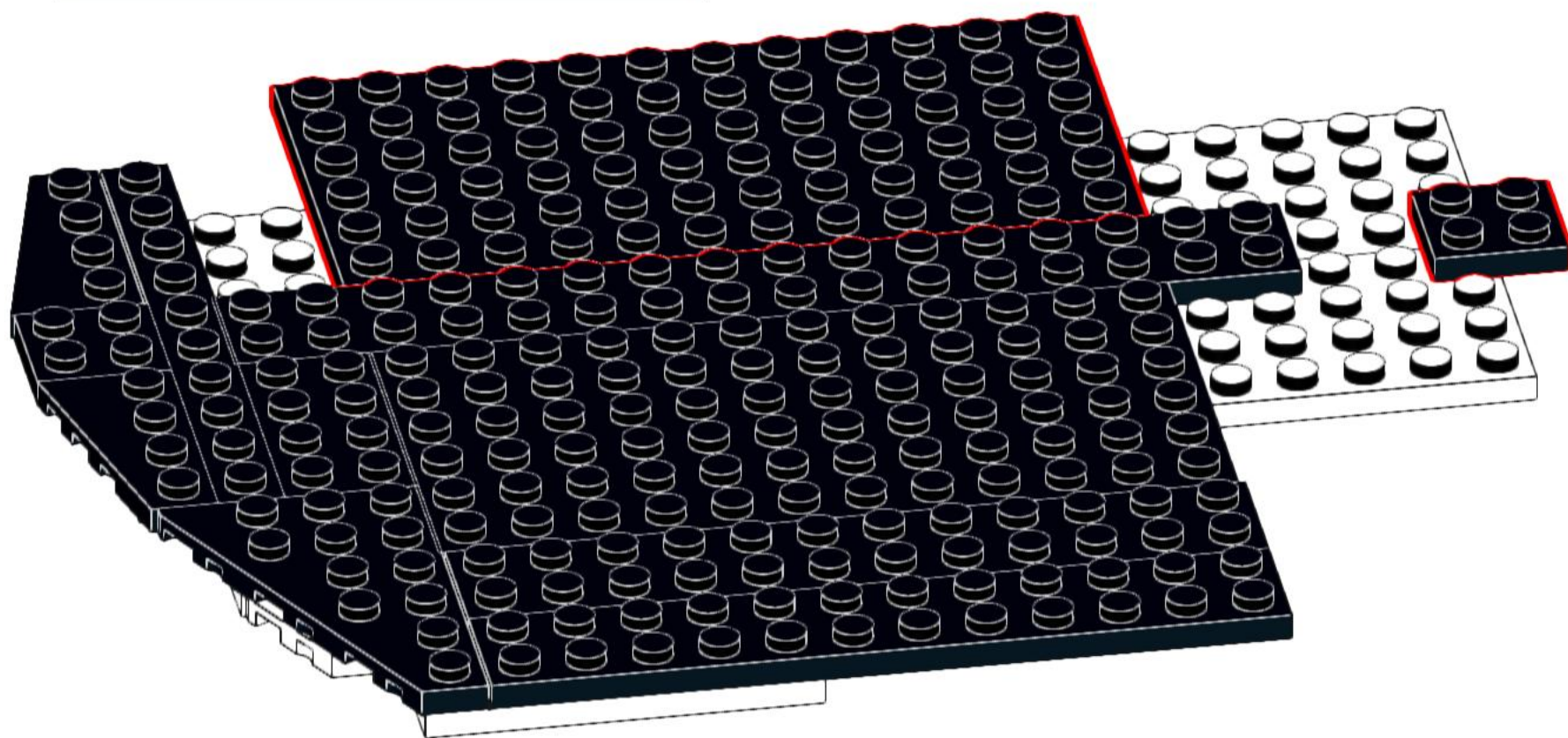
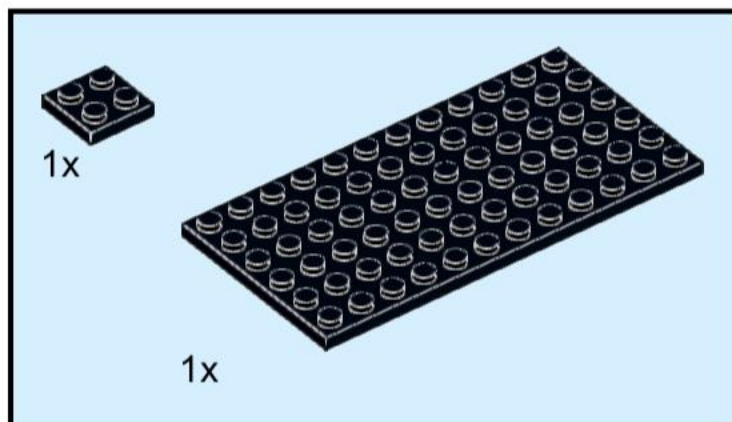

10

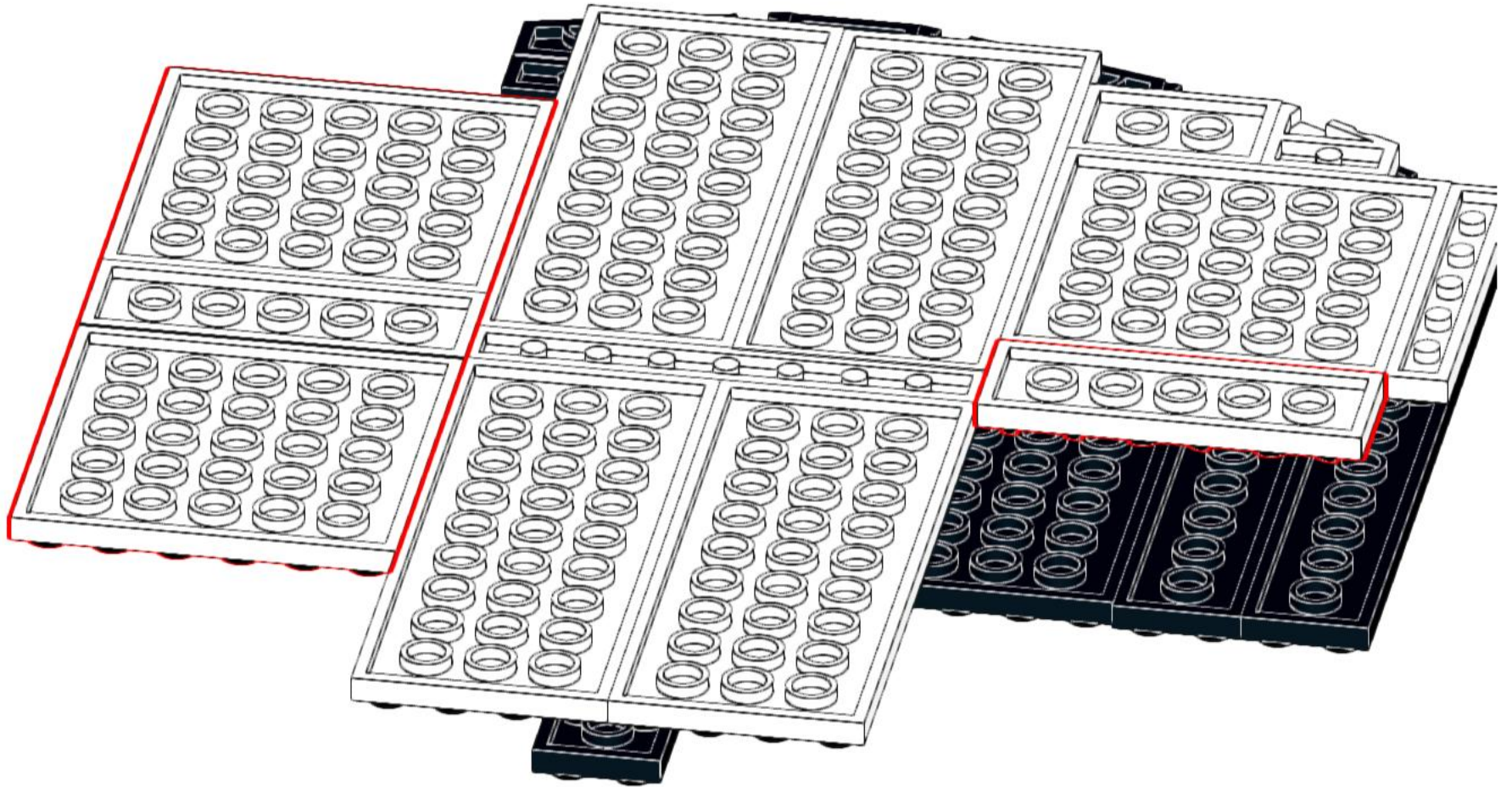
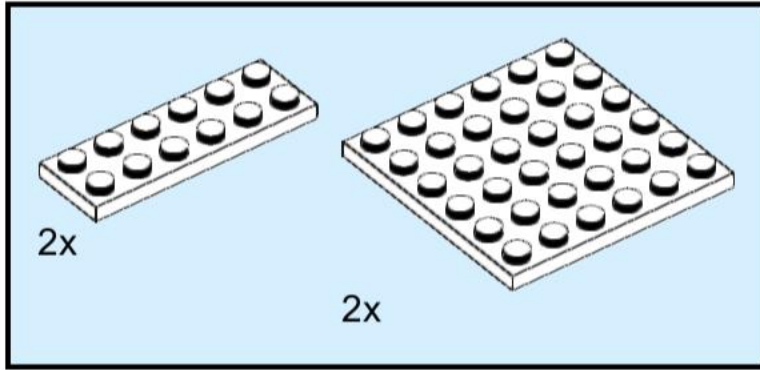

11

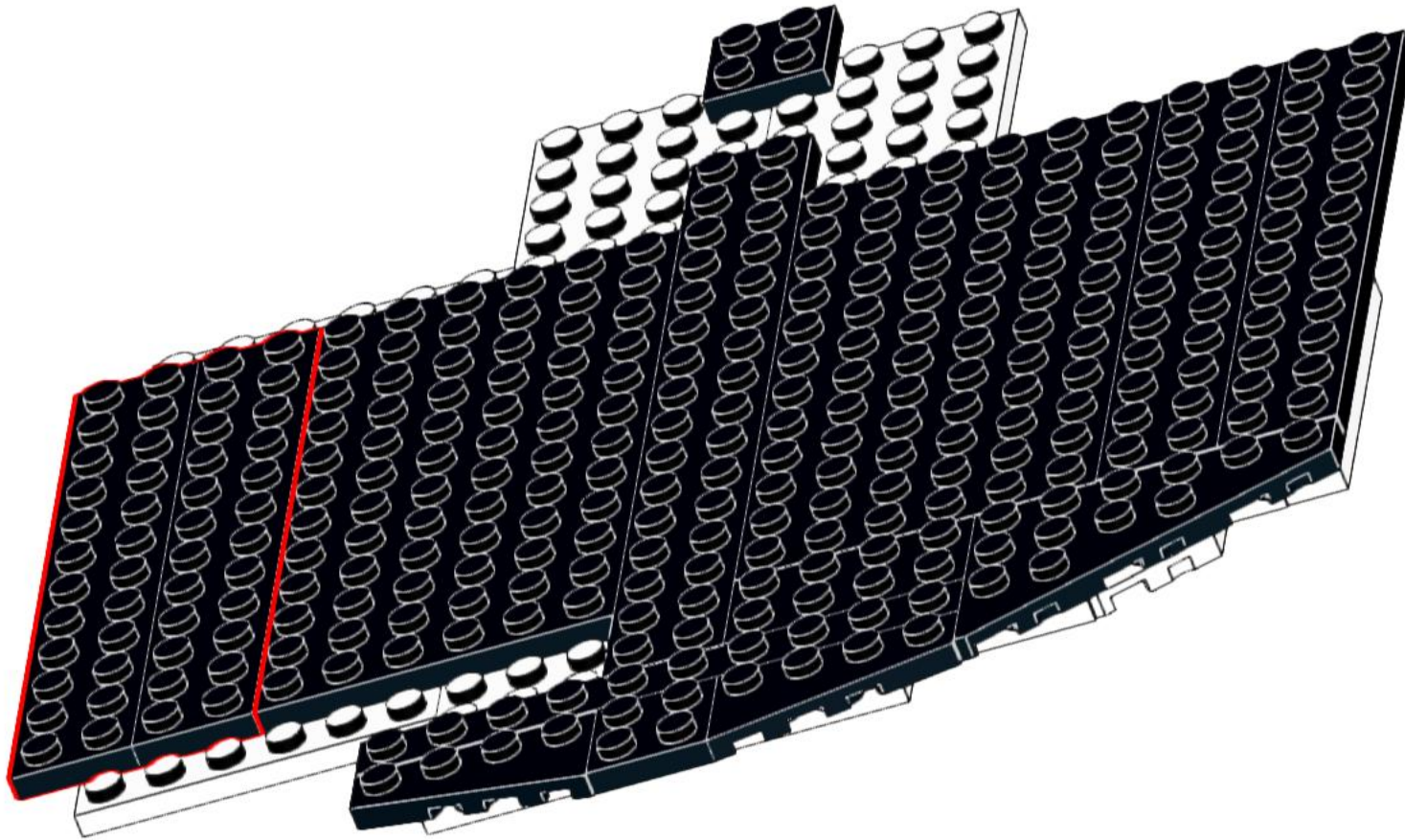
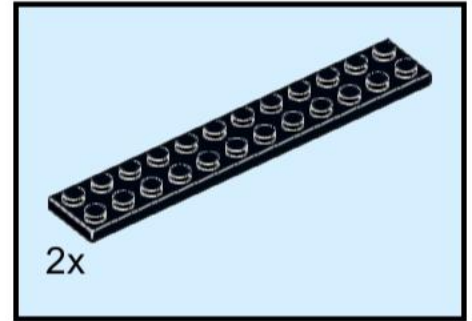

12

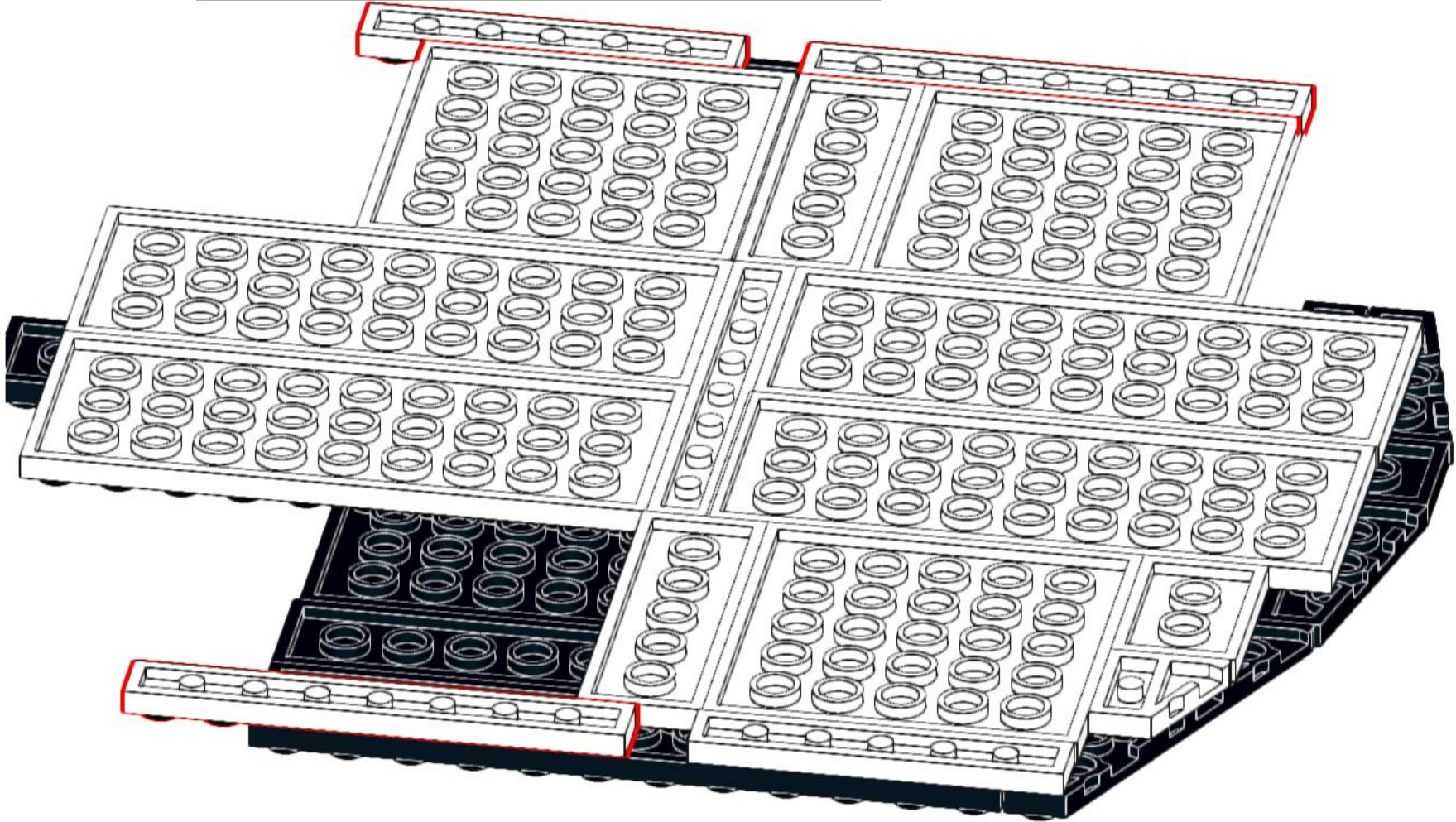
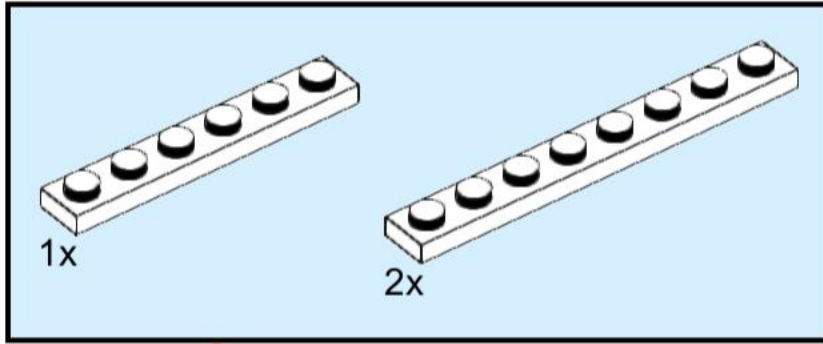

13

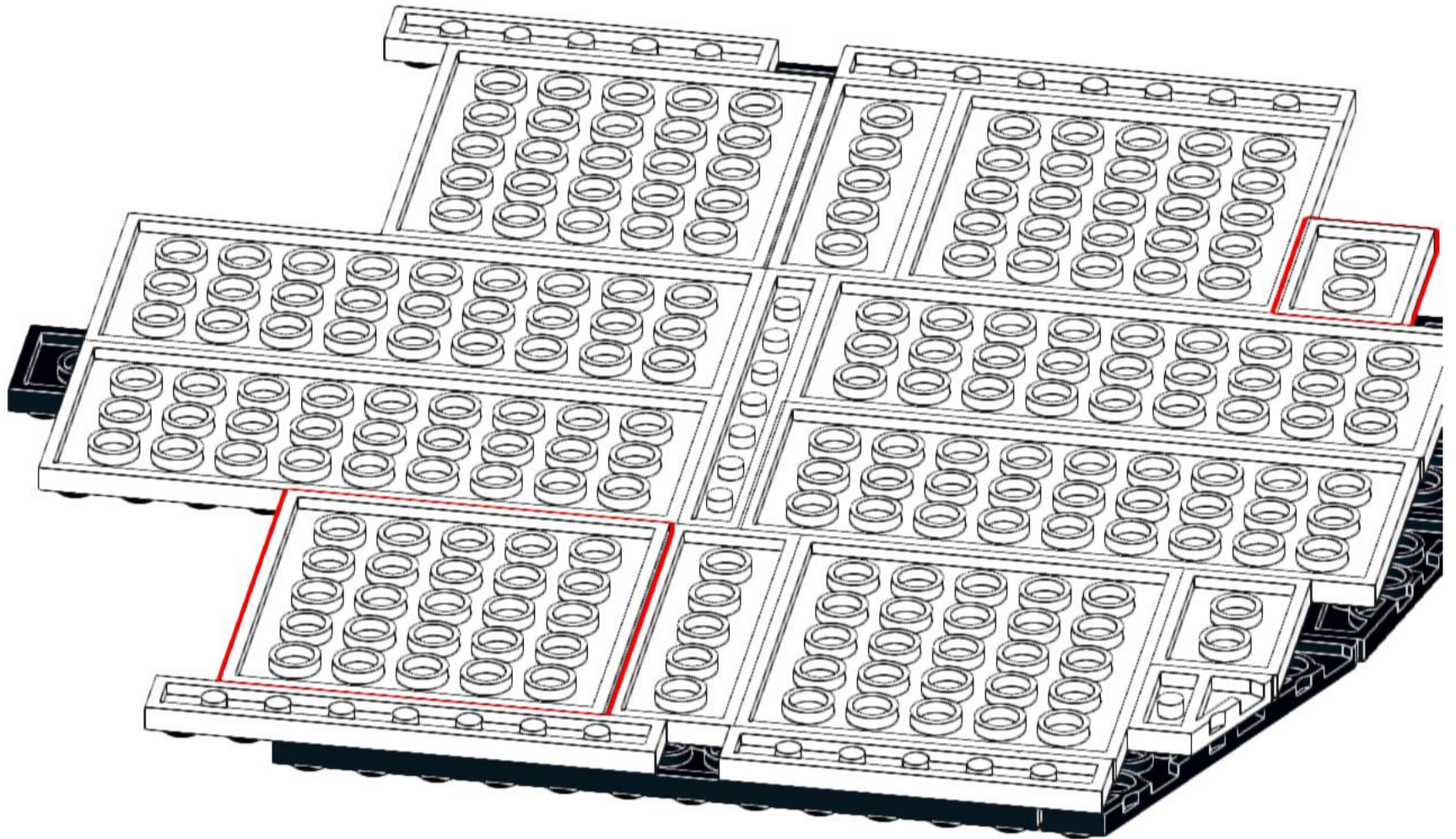
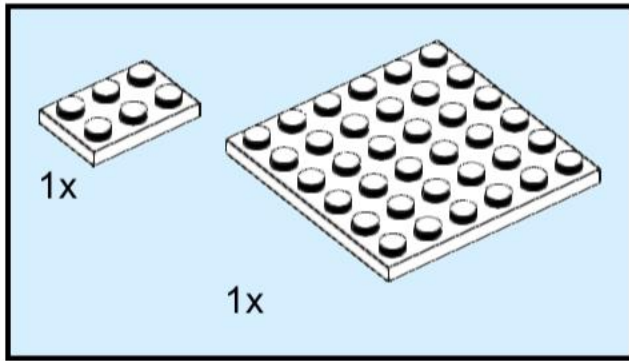

14

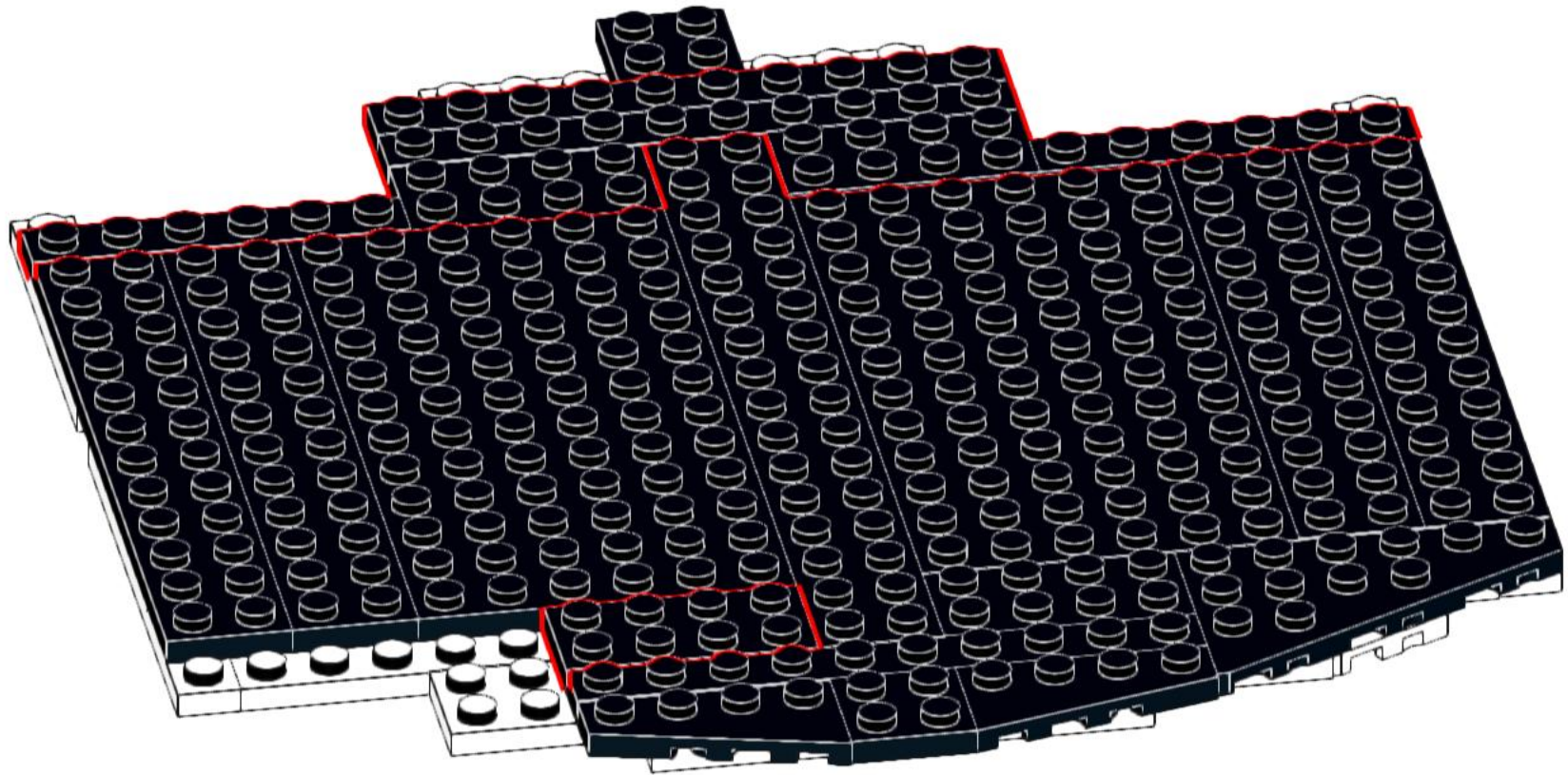
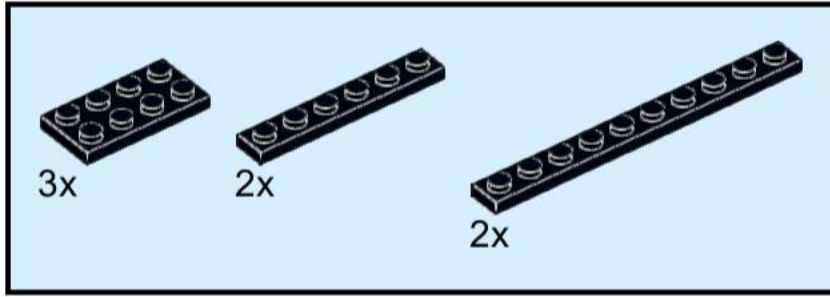

15

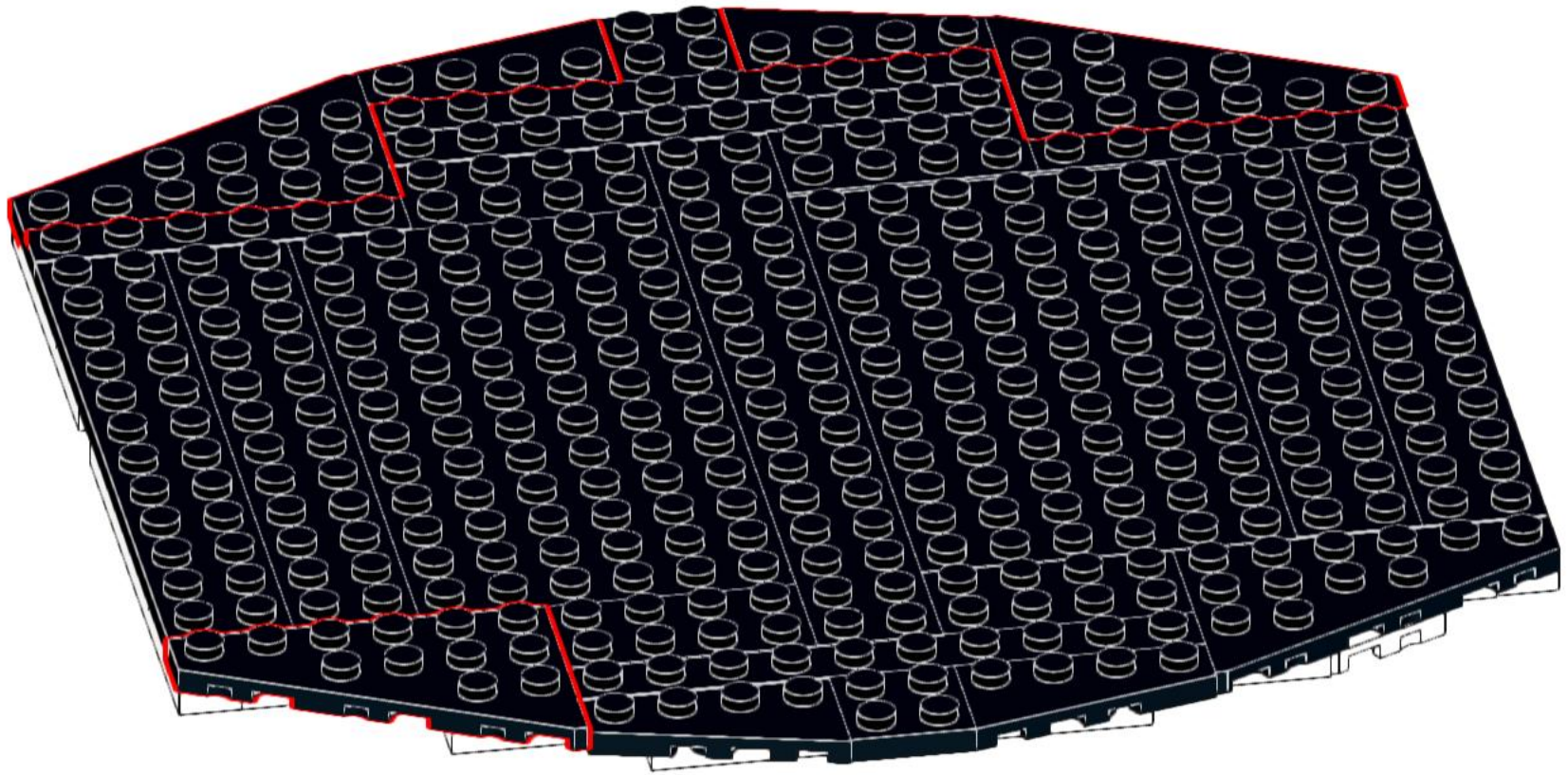
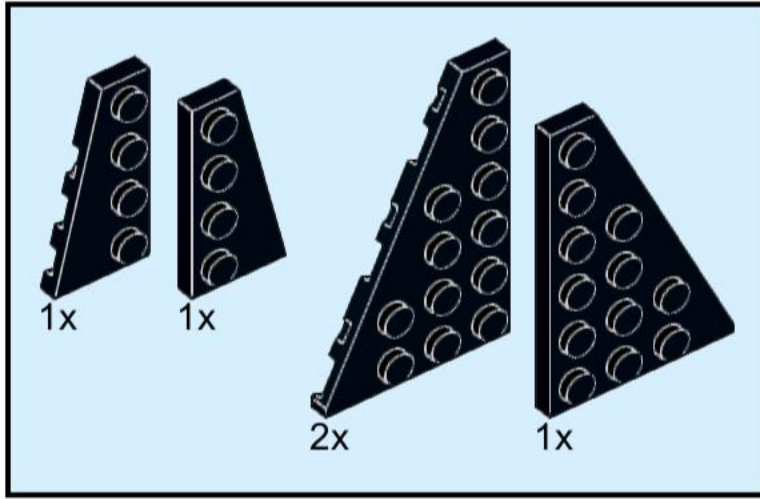

16

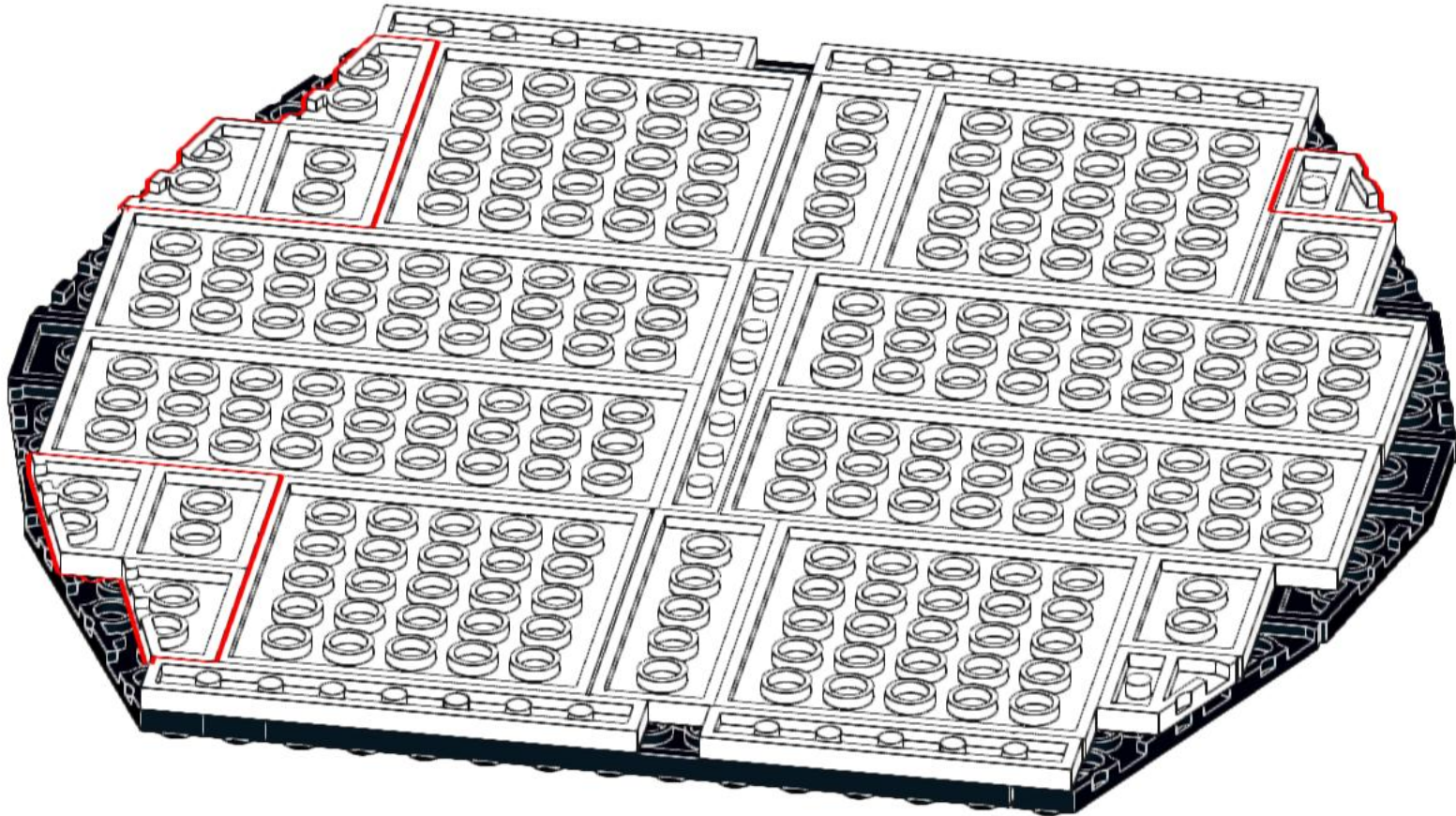
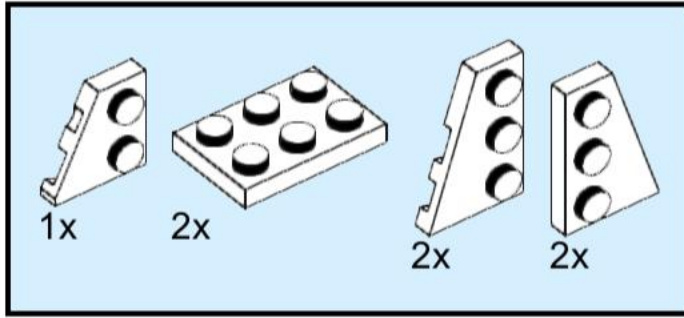

17

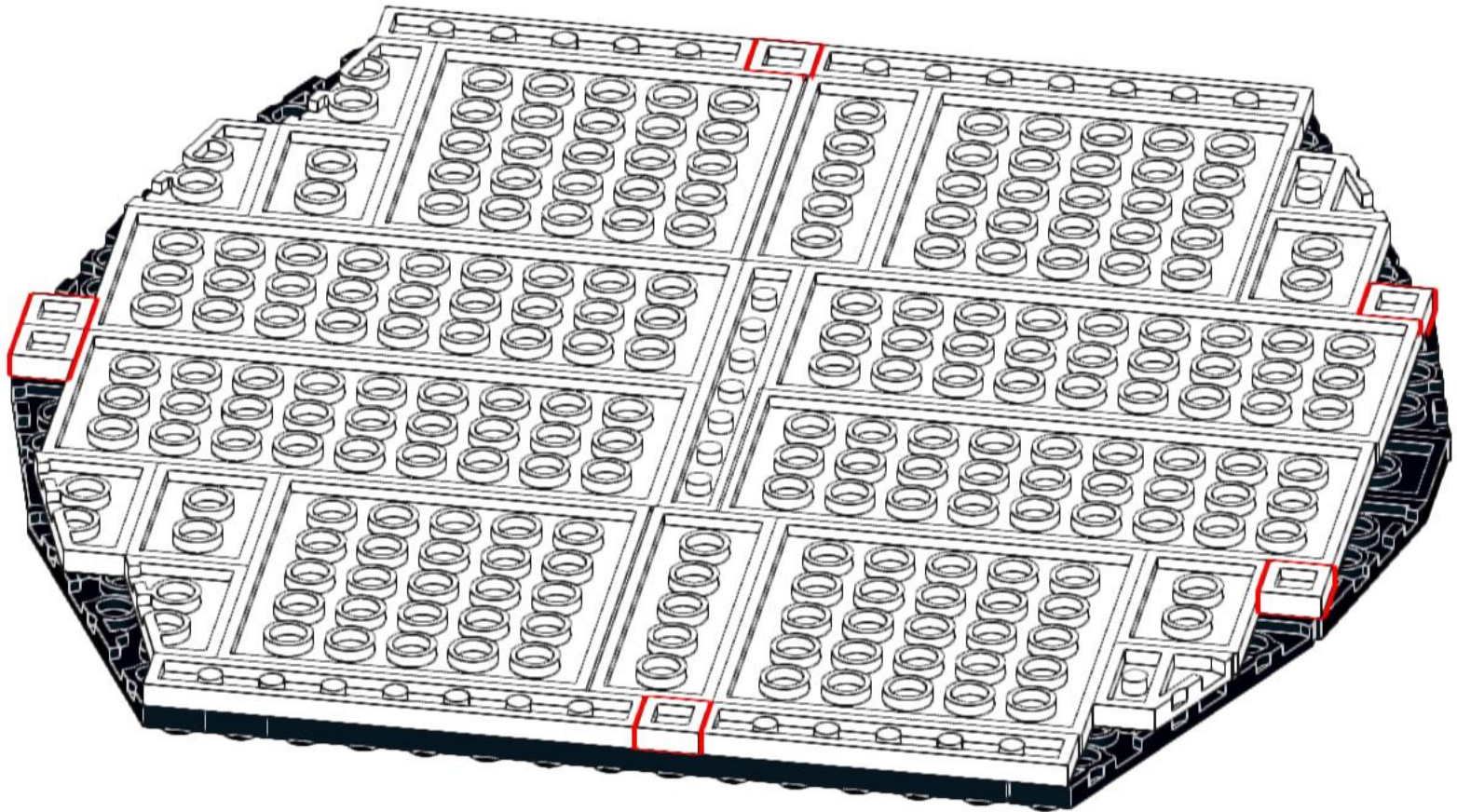
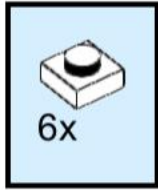

18

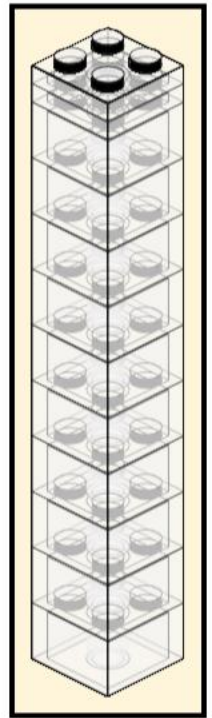
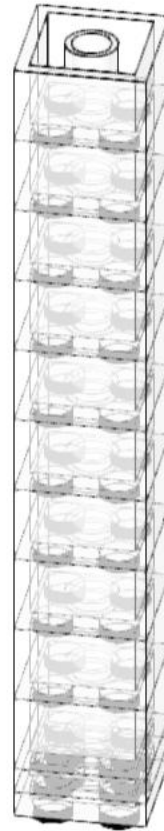
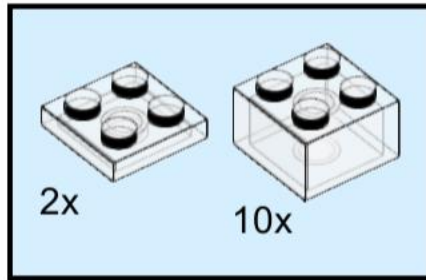

4x

19

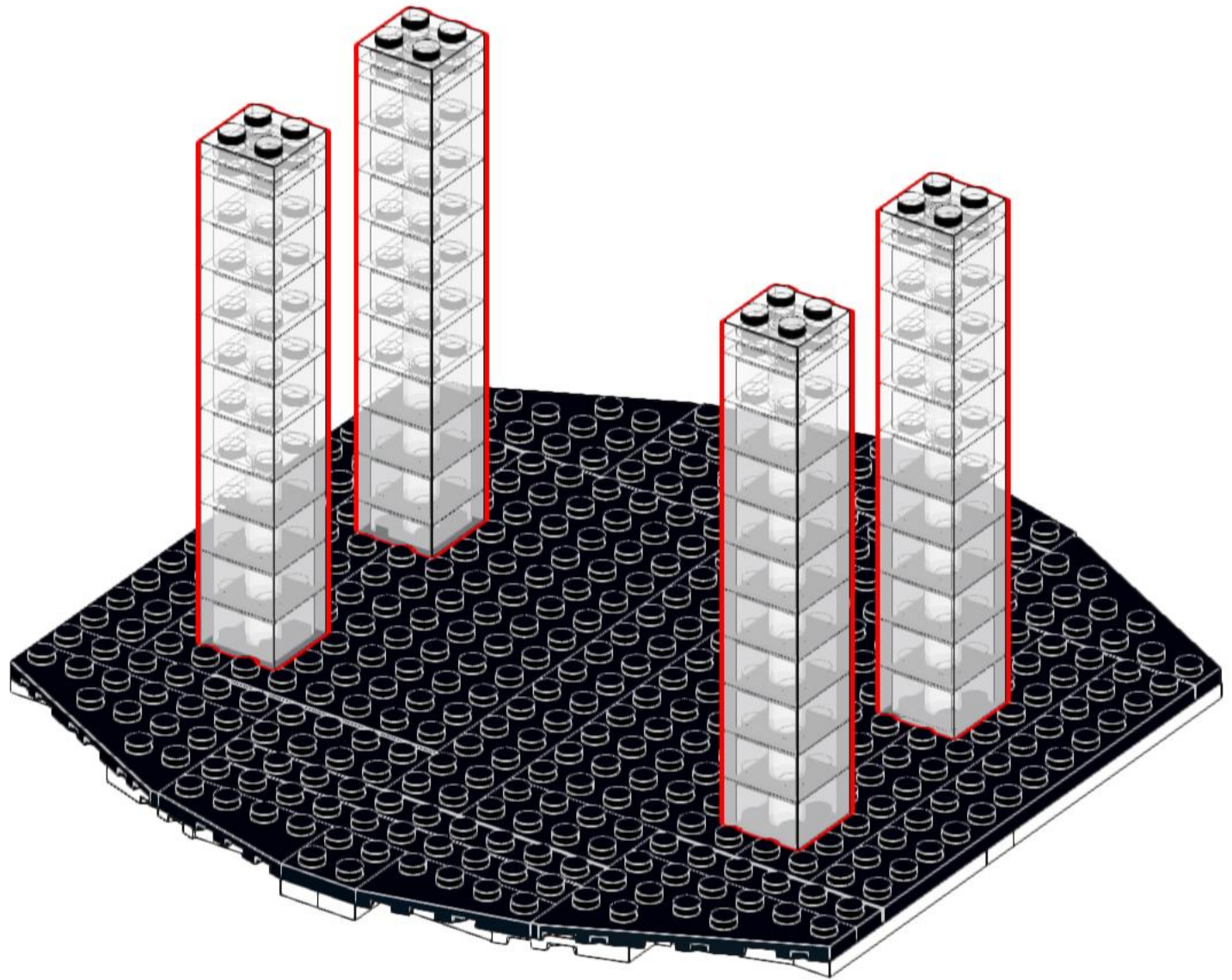

20

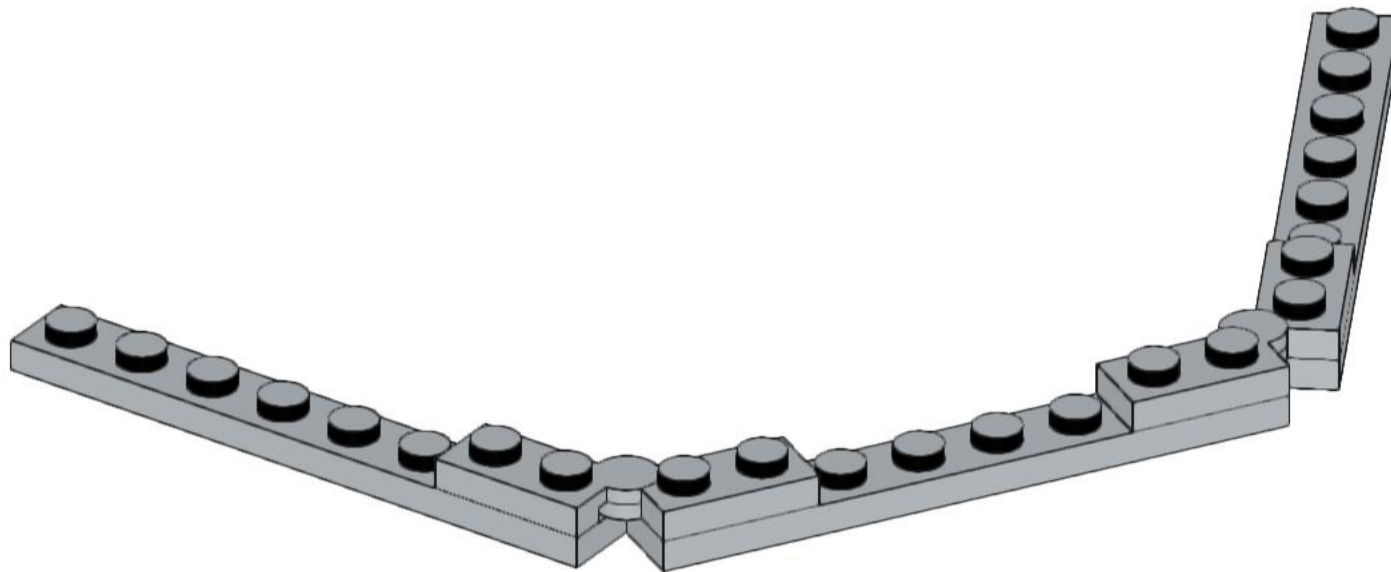
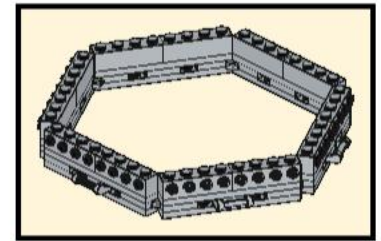
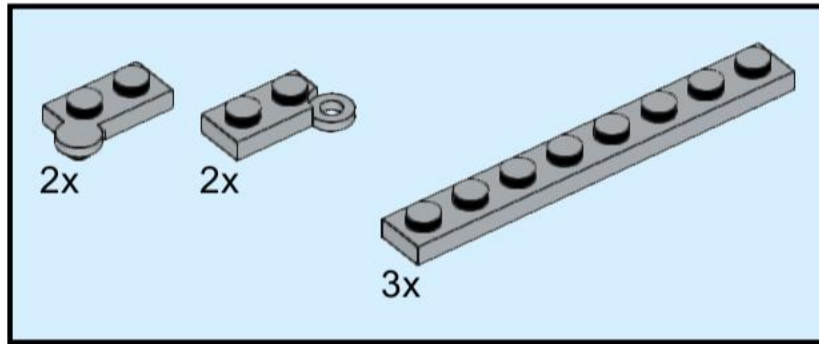

21

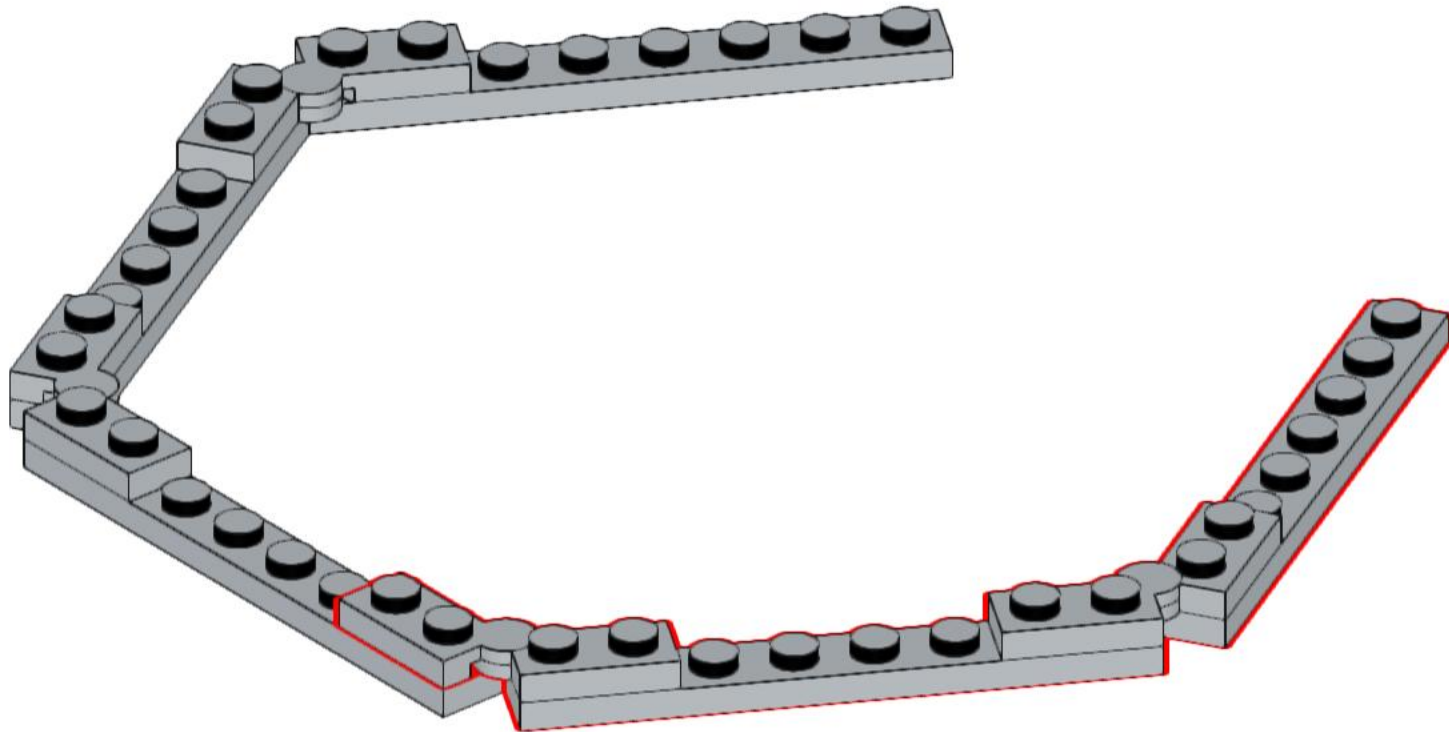
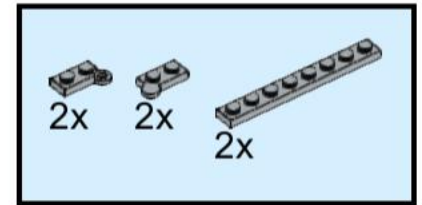

22

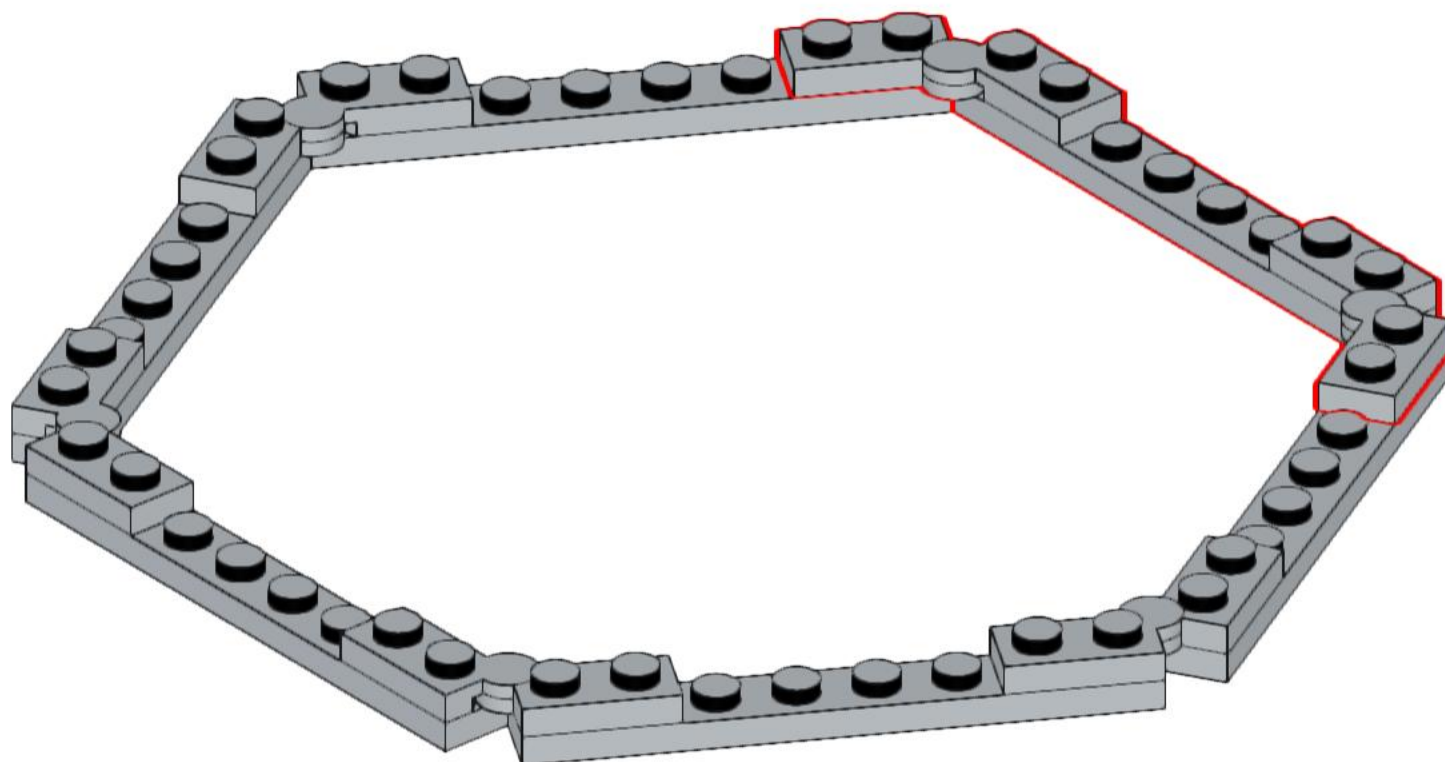
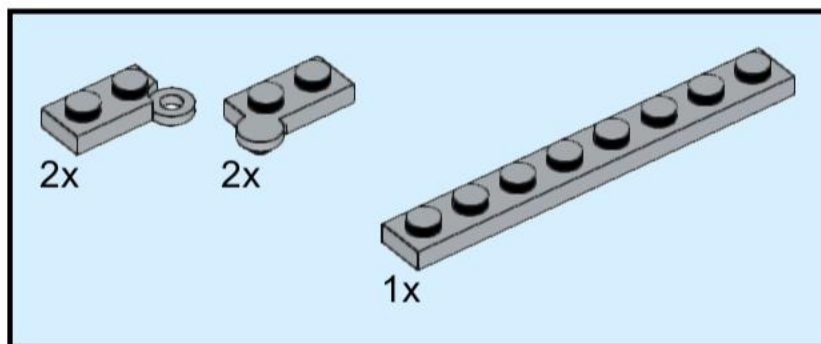

23

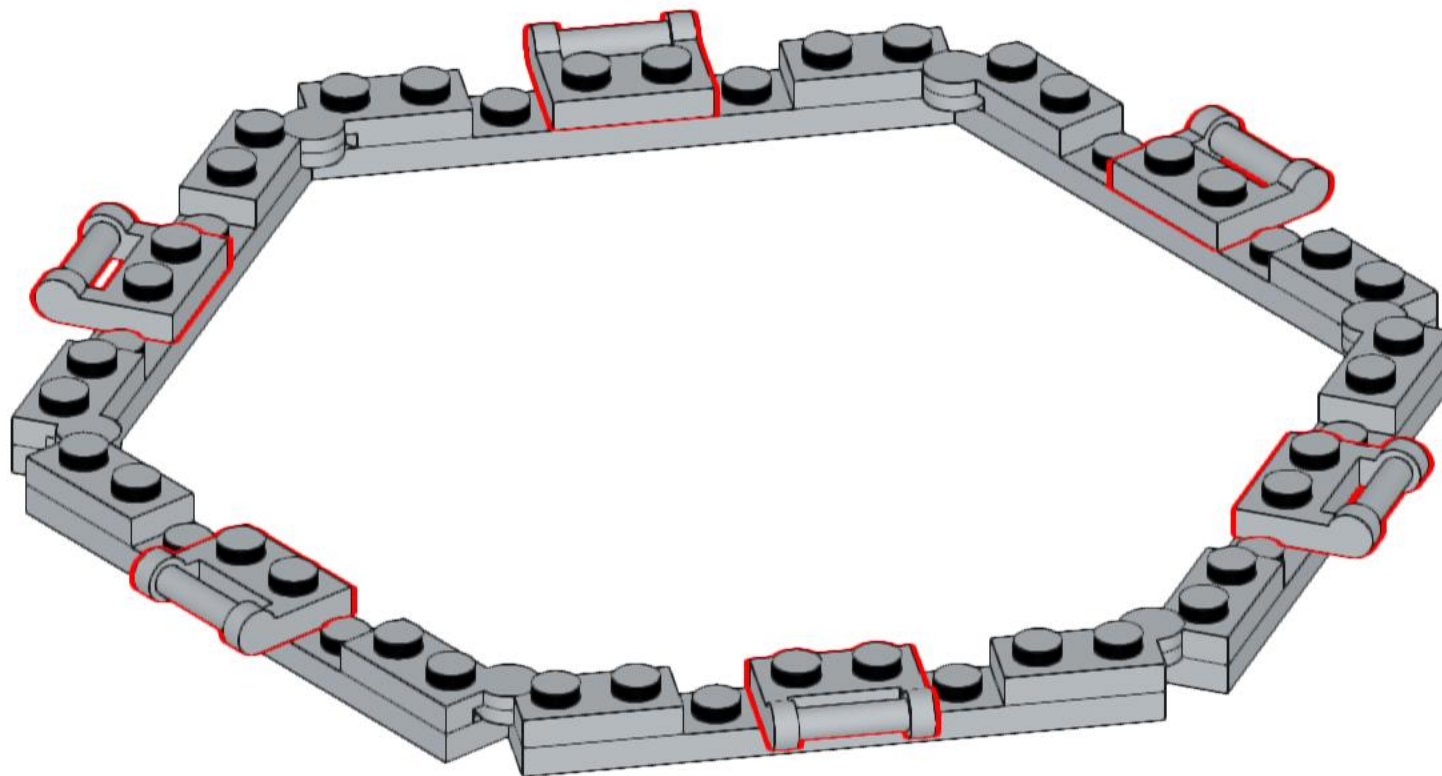
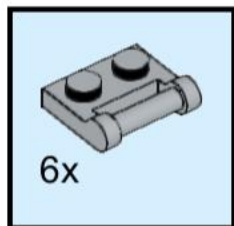

24

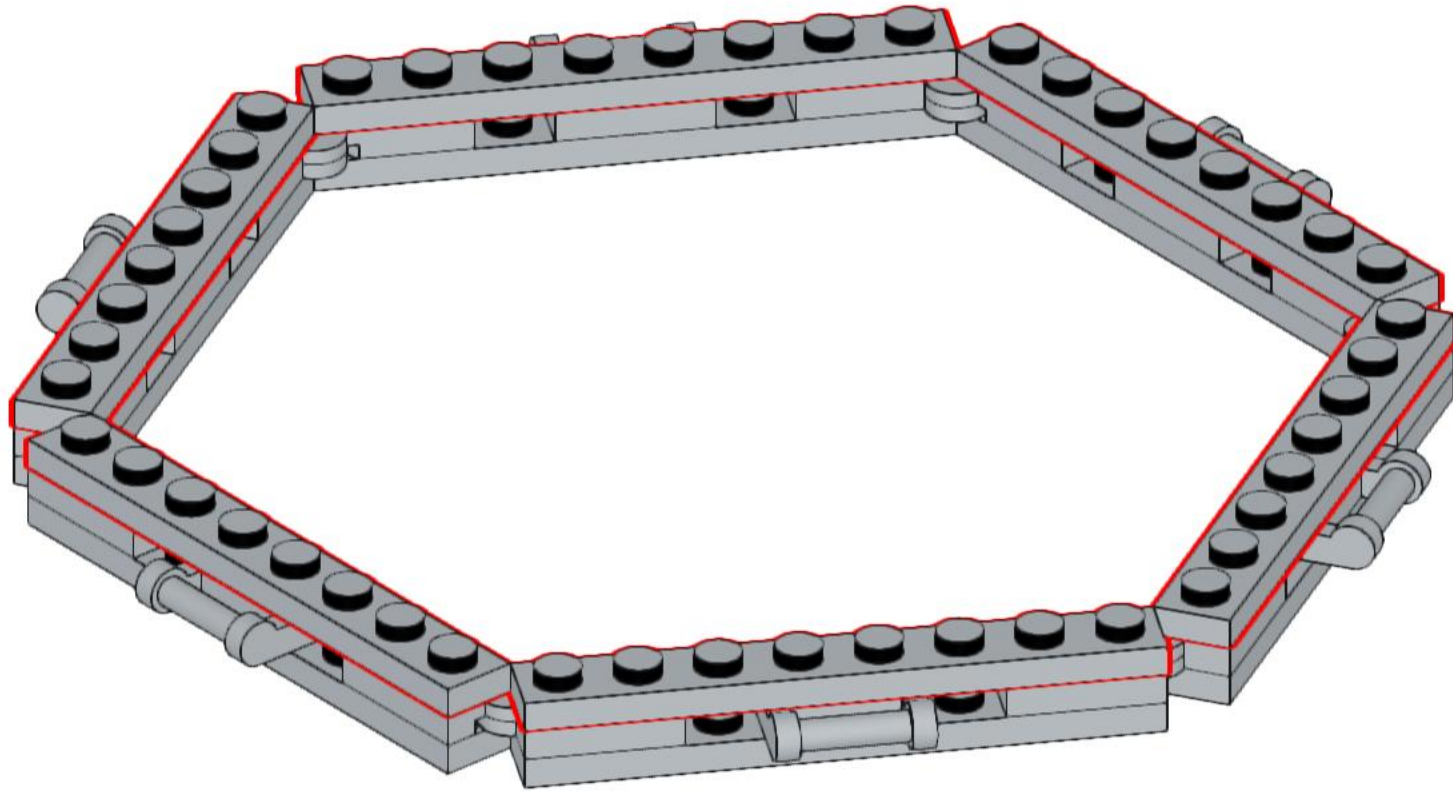
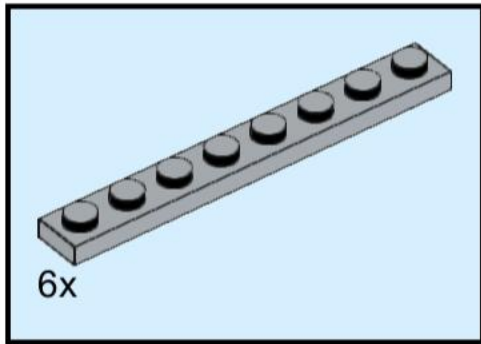

25

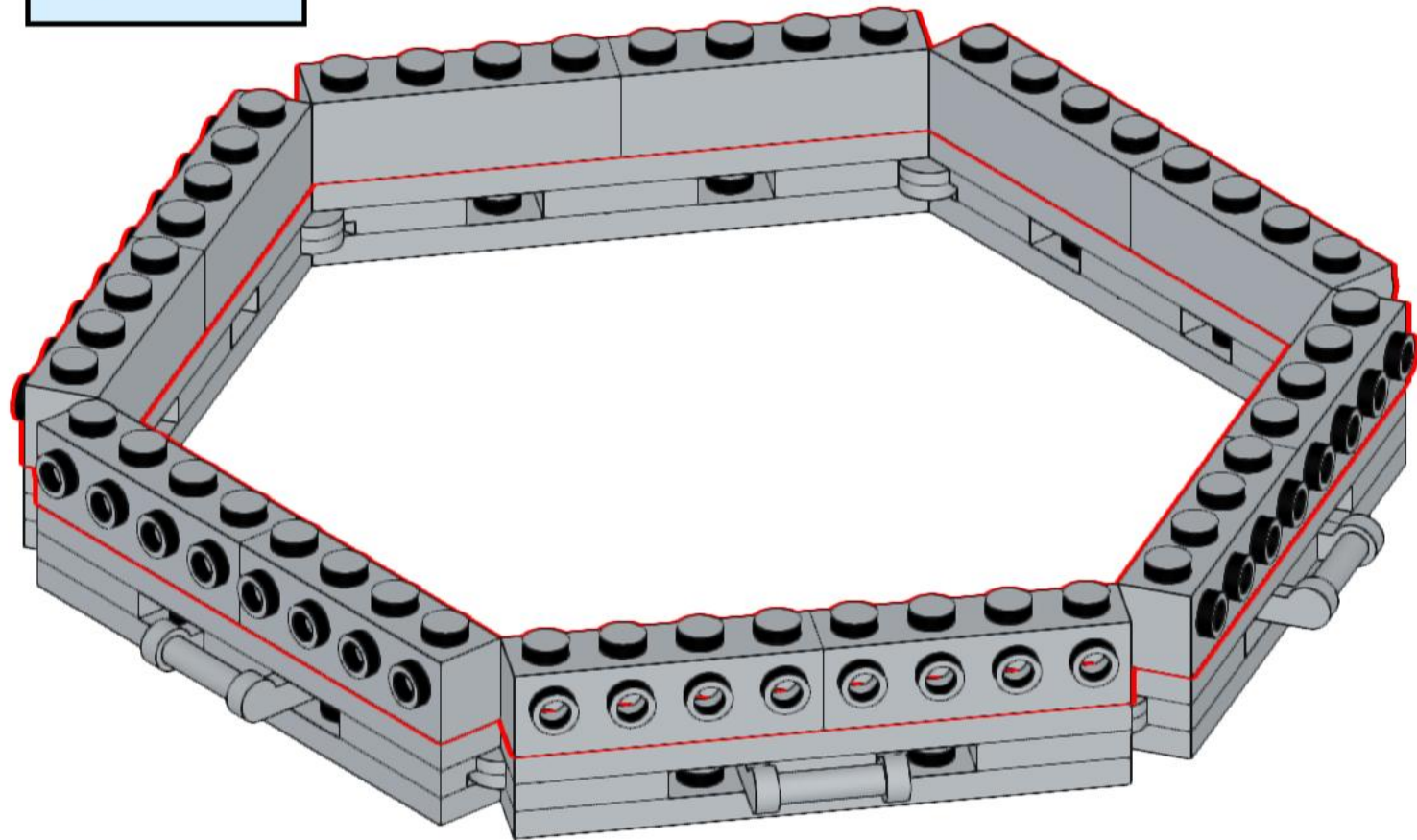
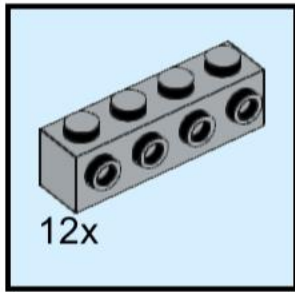

26

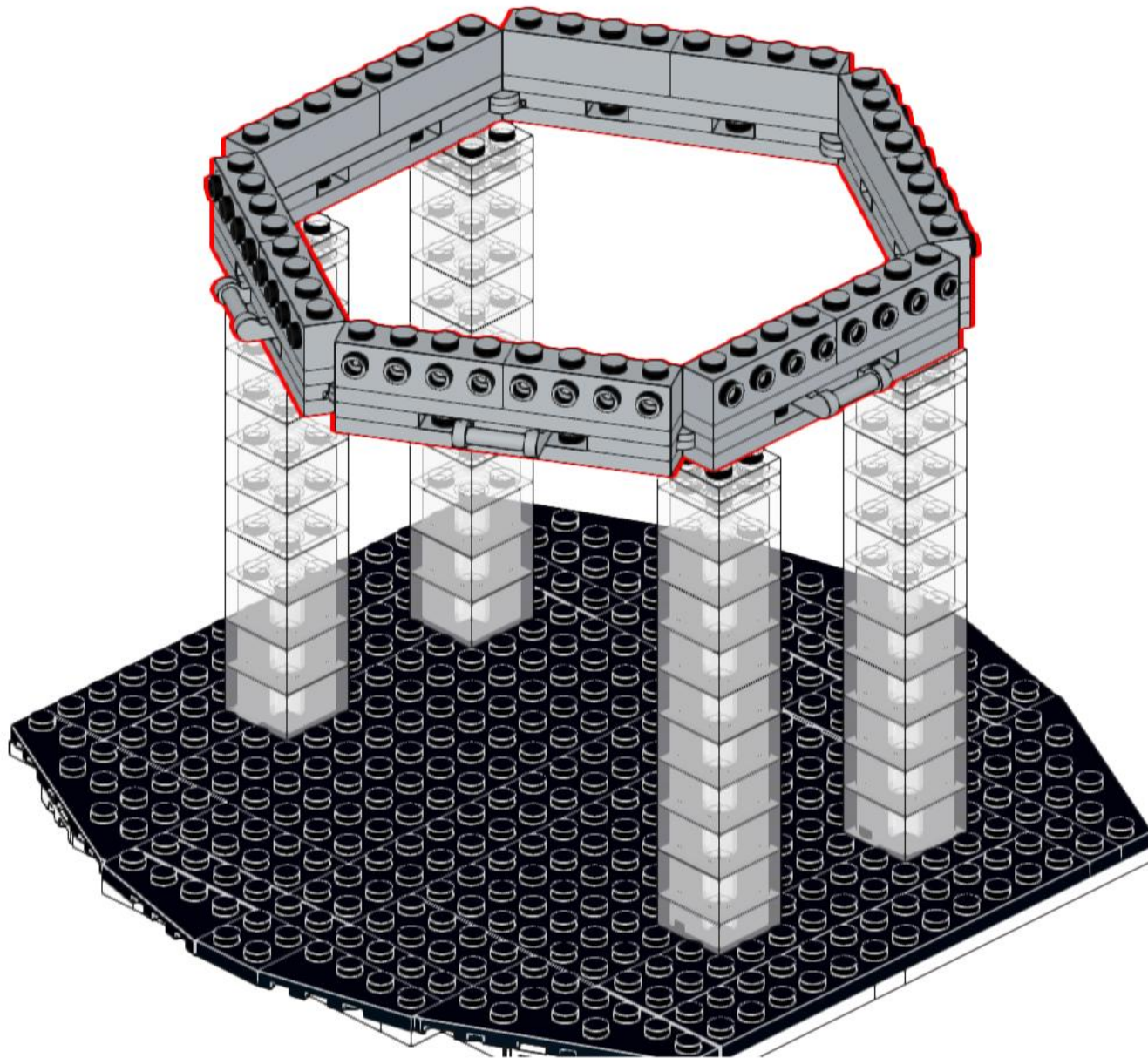

27

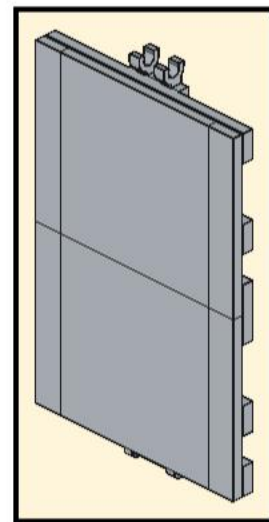
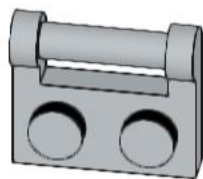
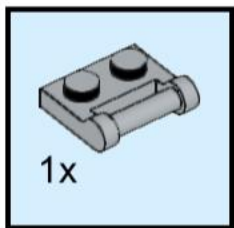

28

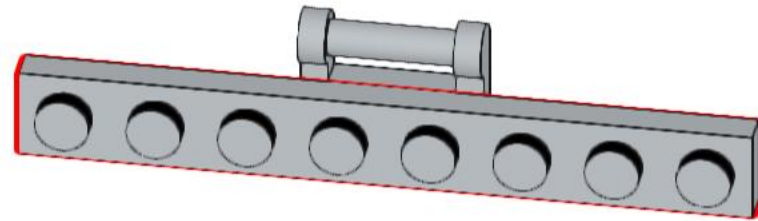
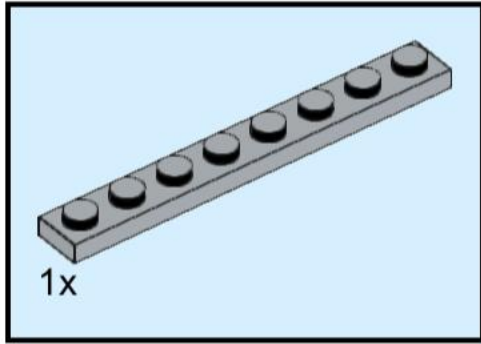

29

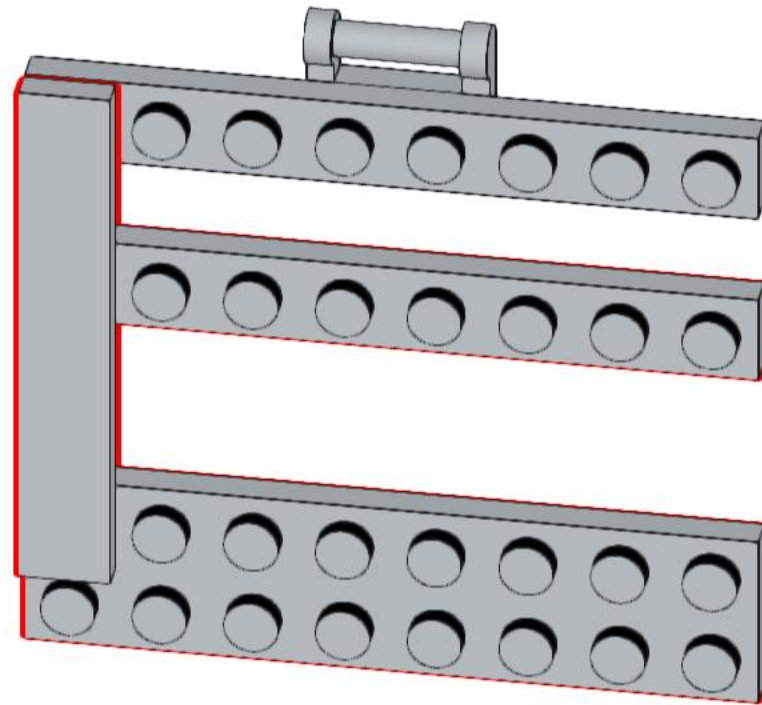
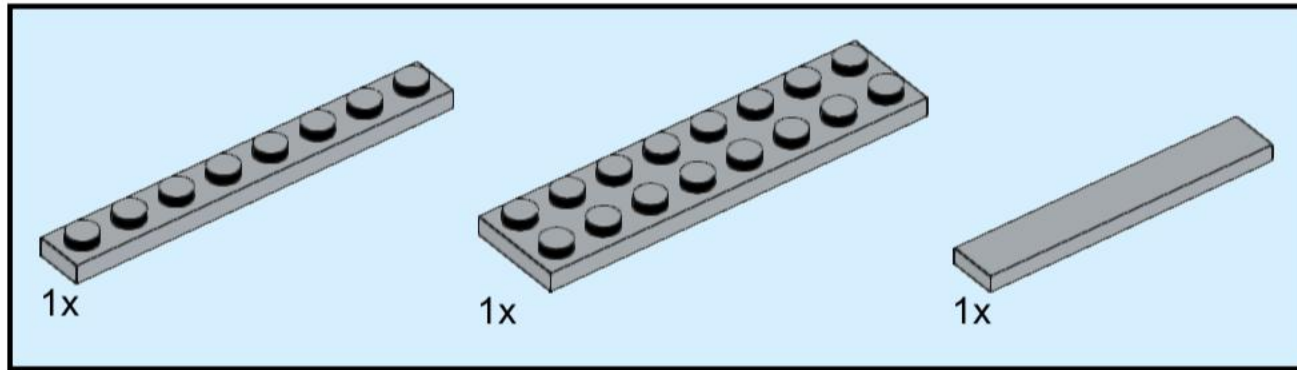

30

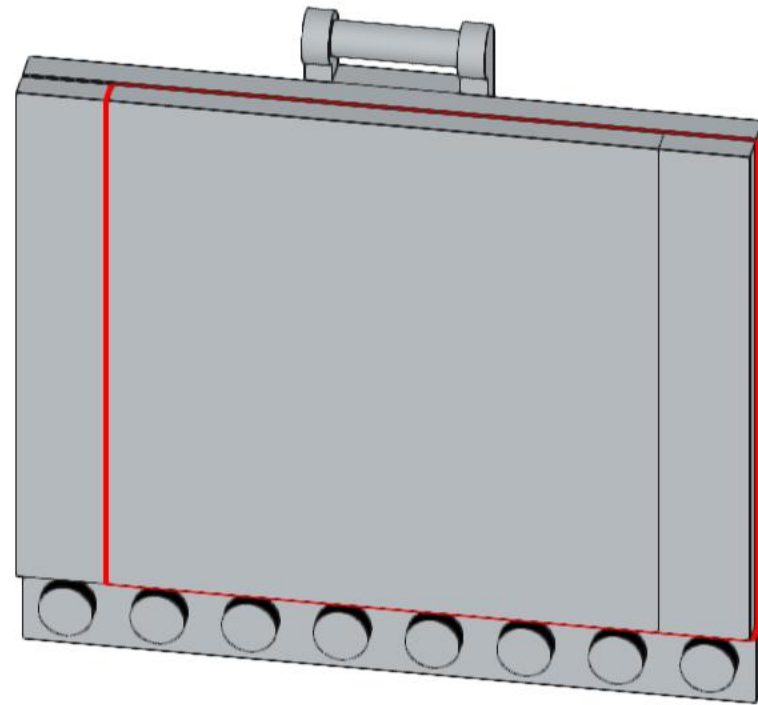
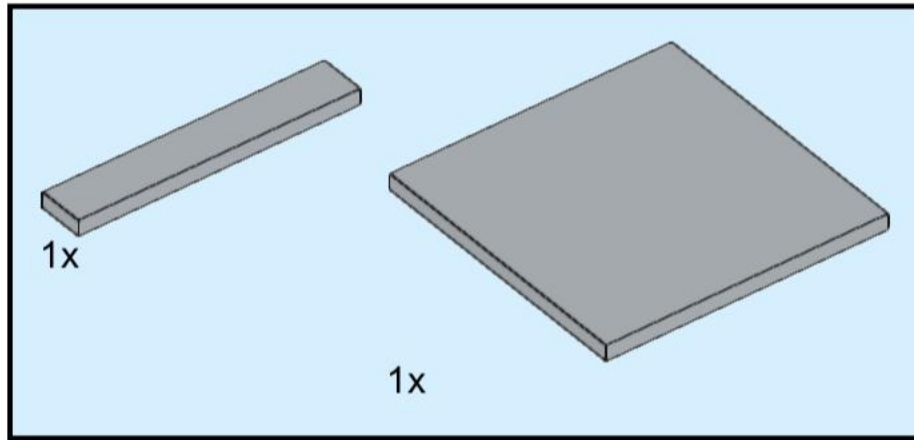

31

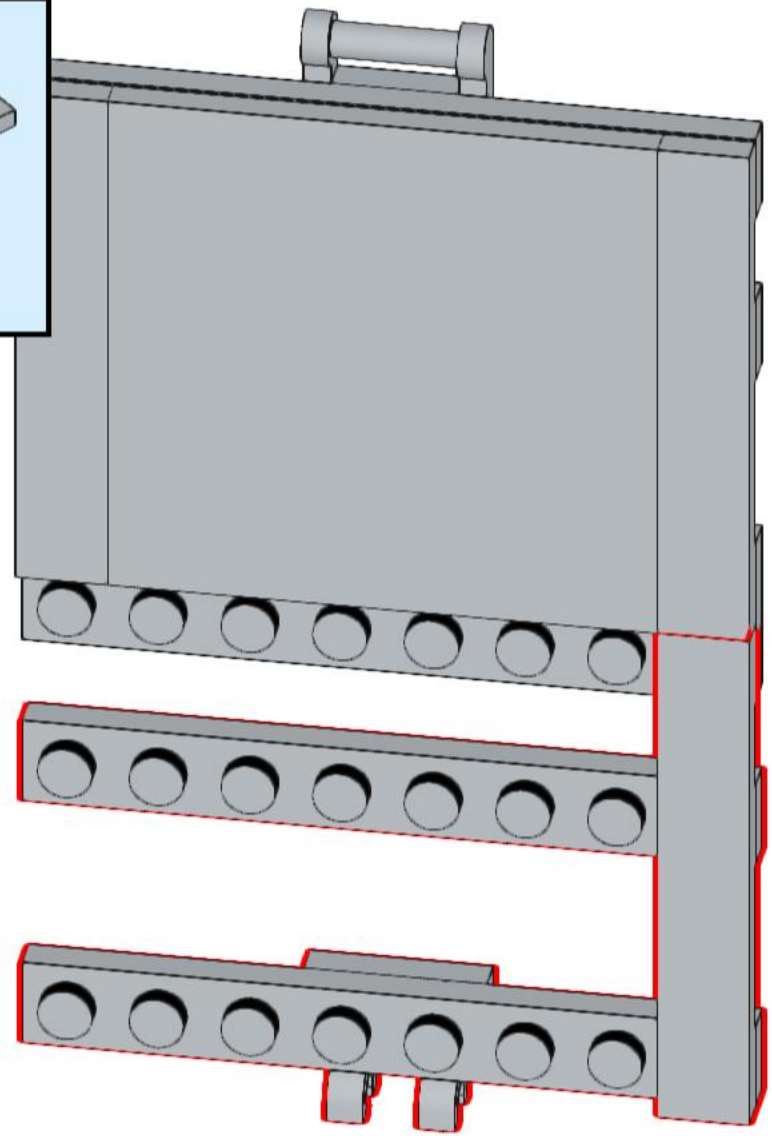
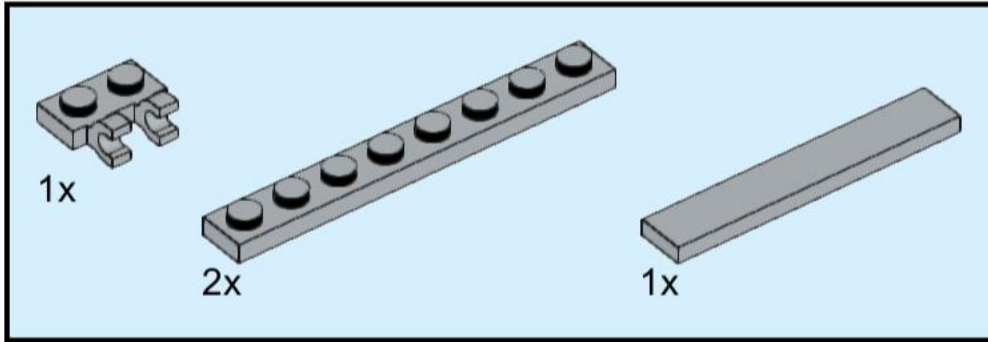

32

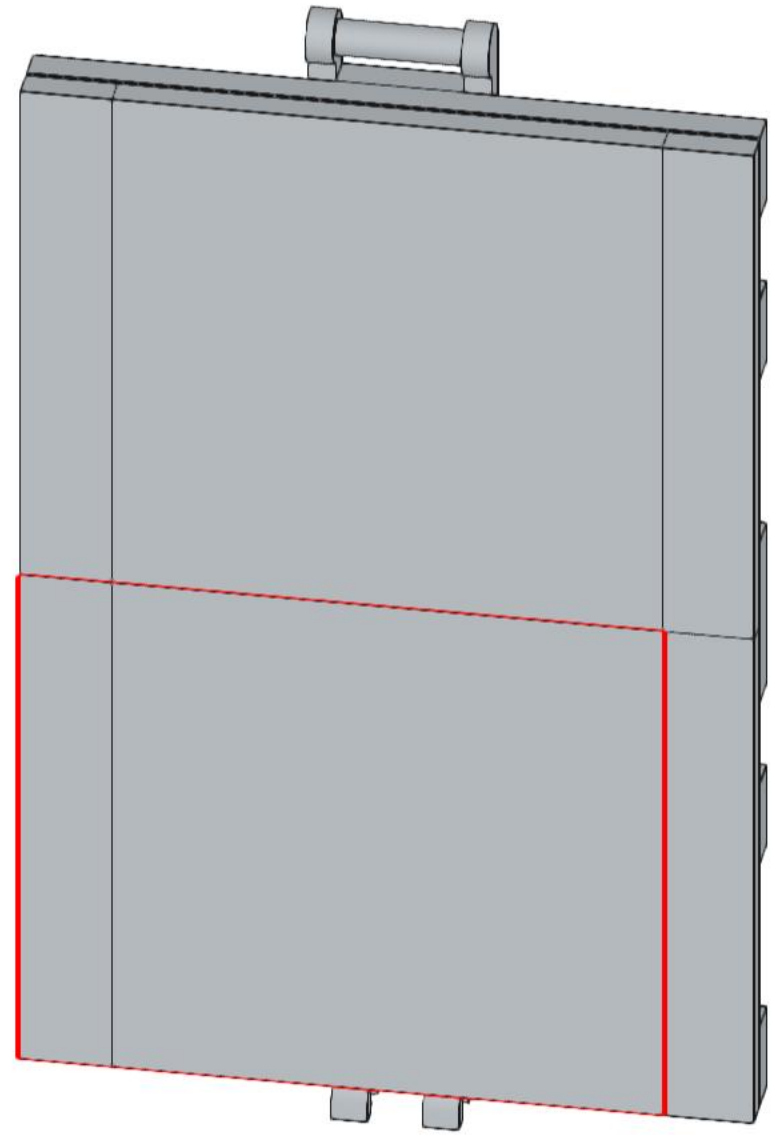
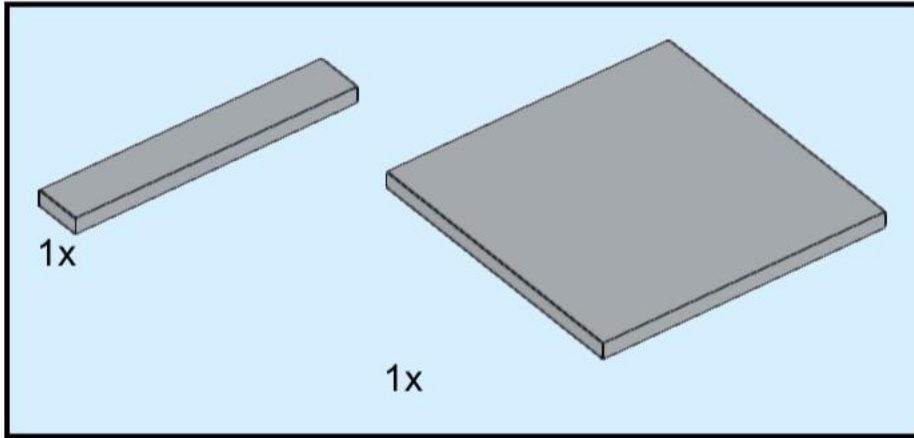

33

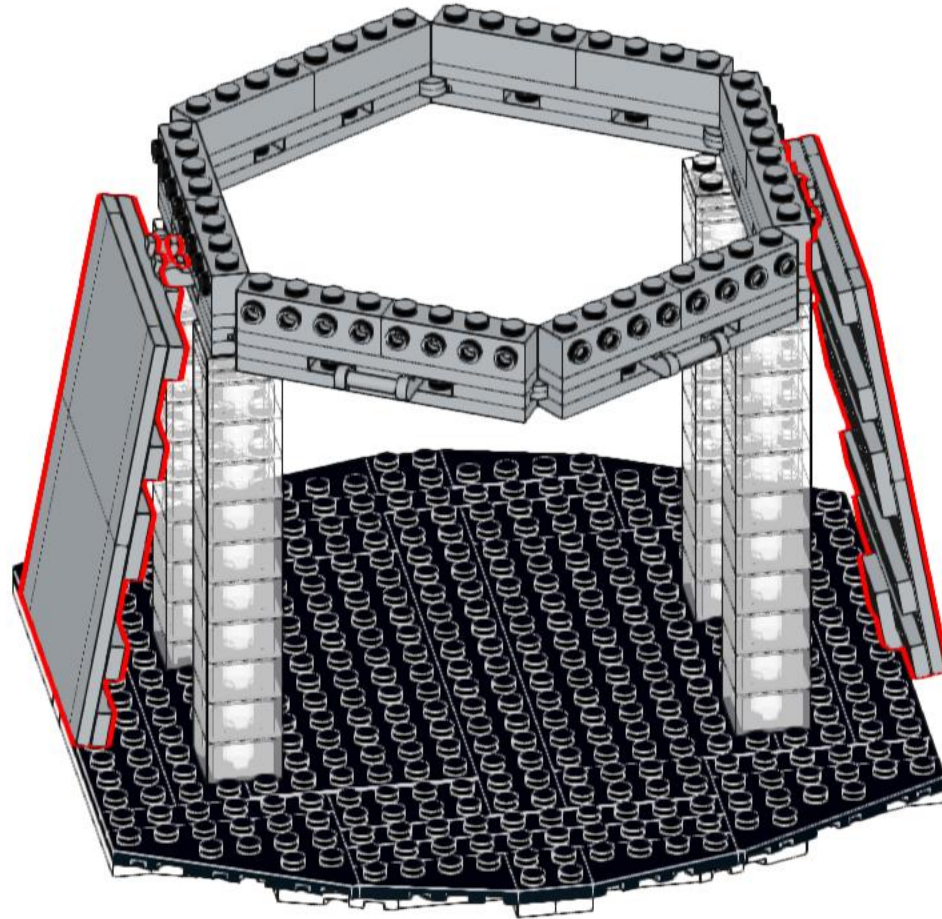

34

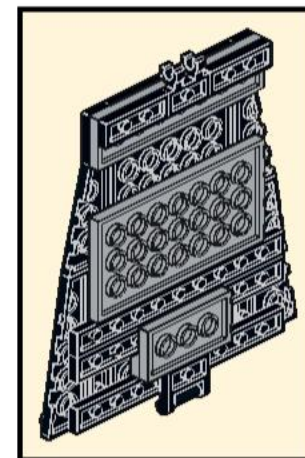
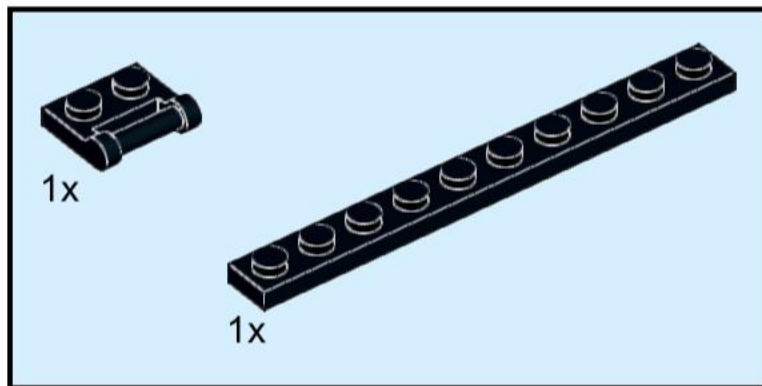

4x



35

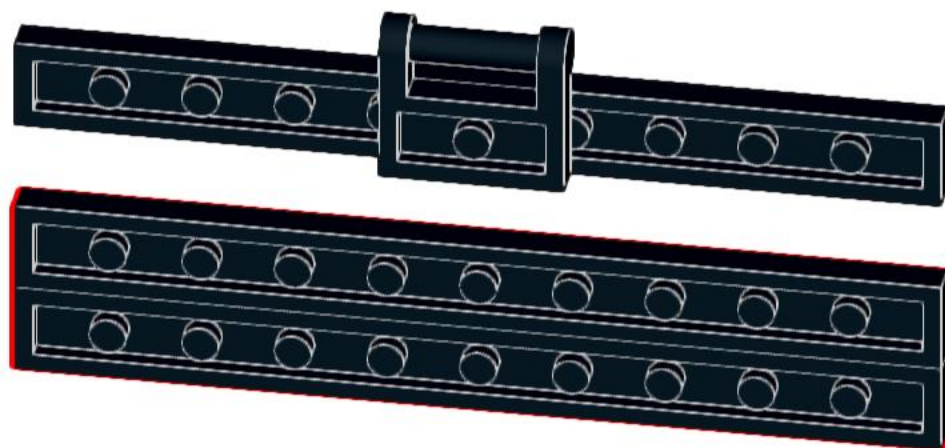
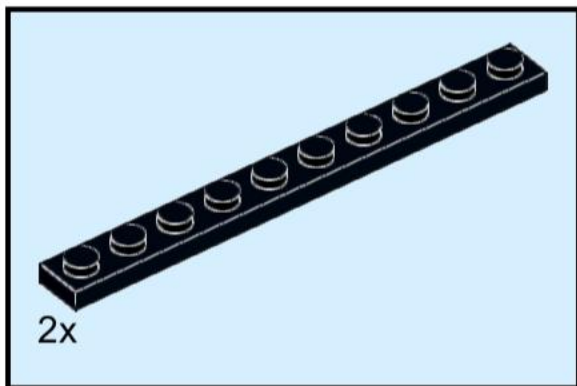

36

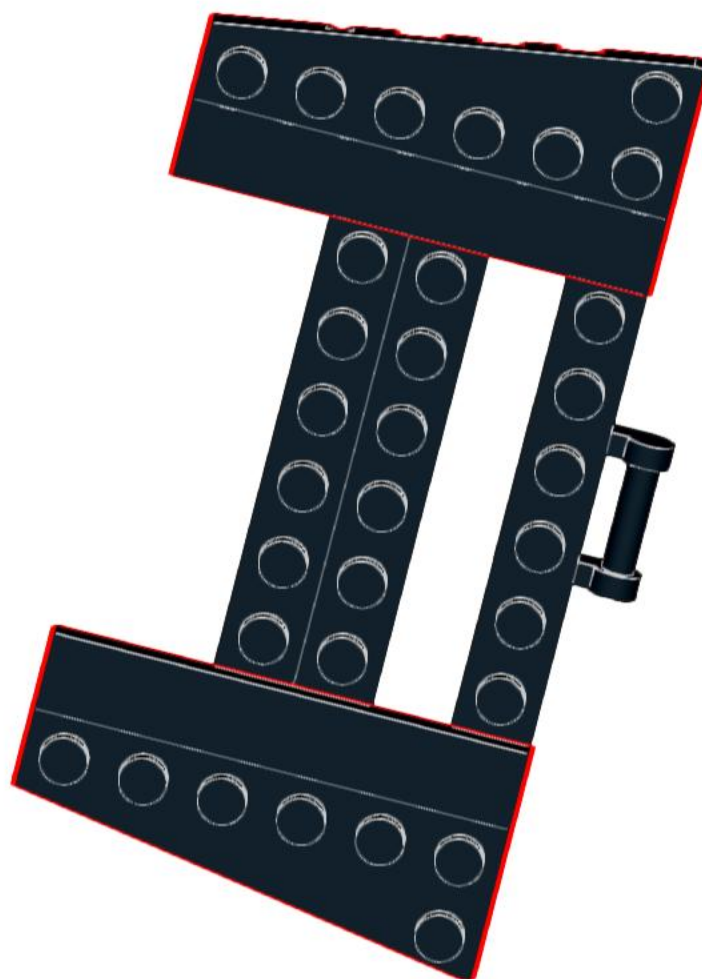
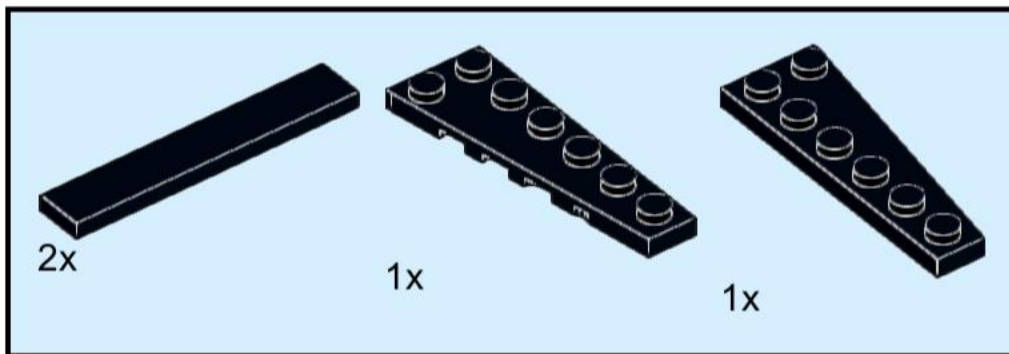

37

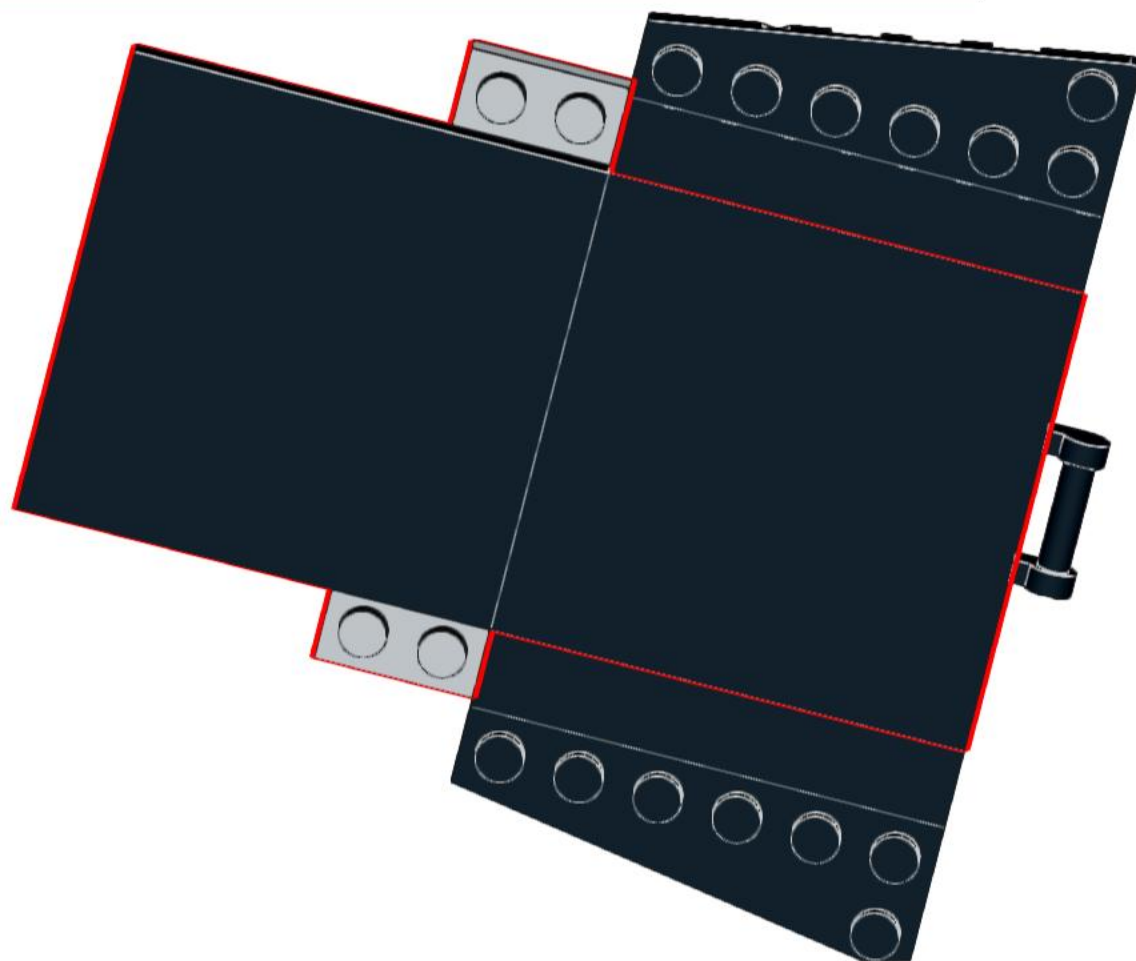
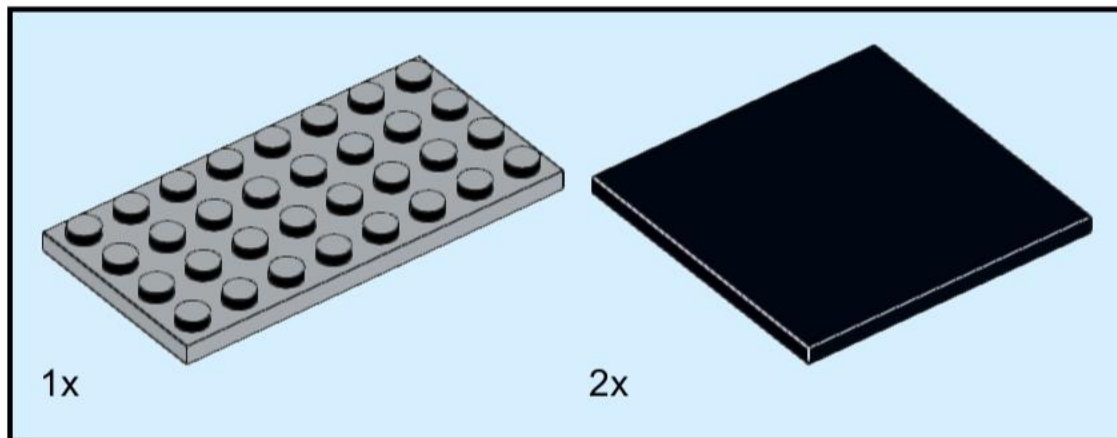

38

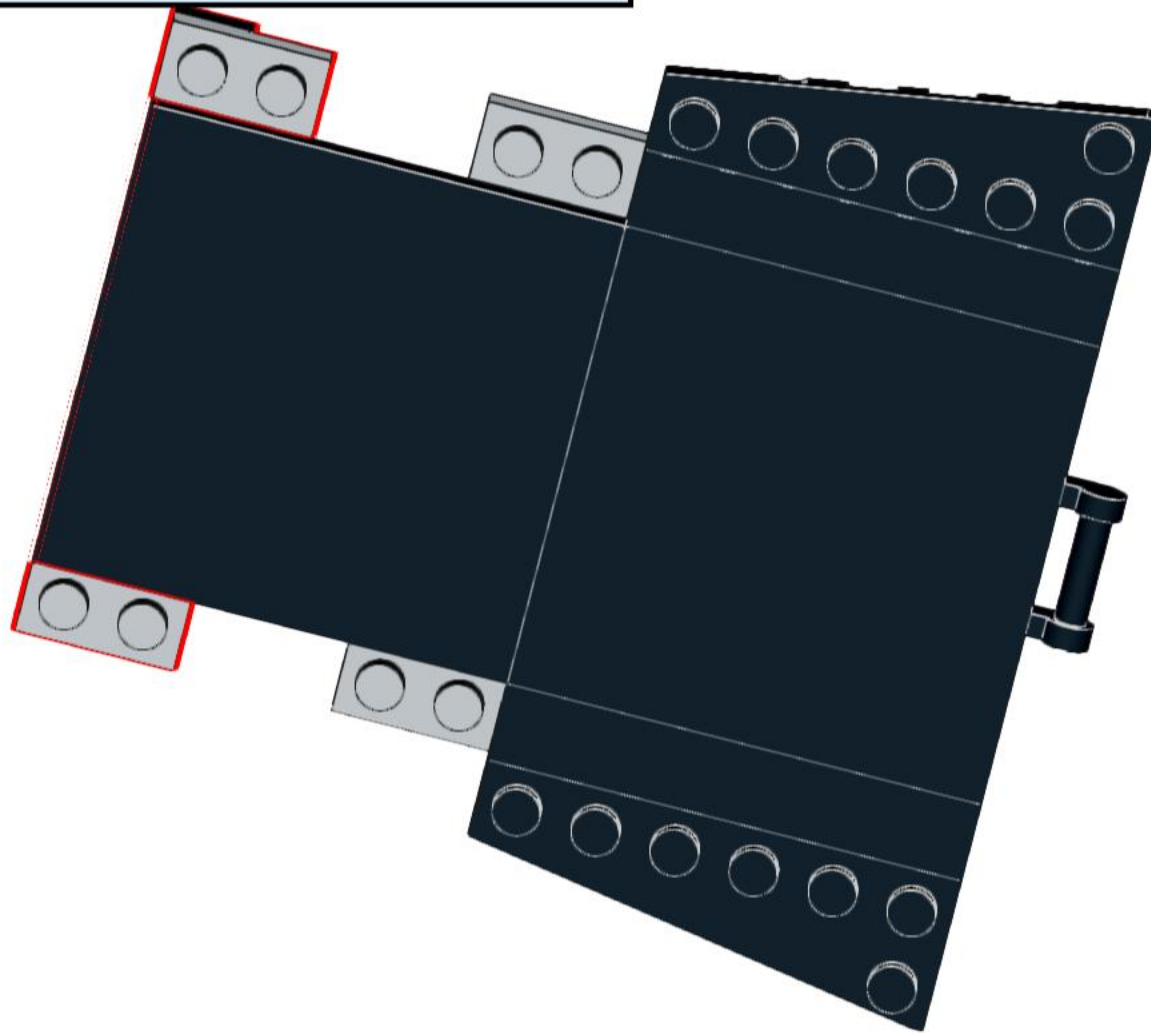
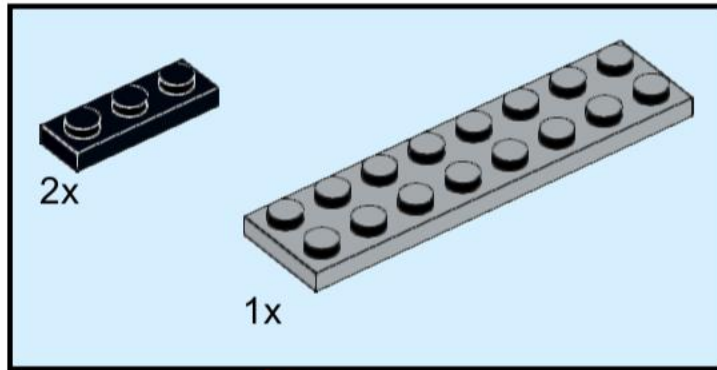

39

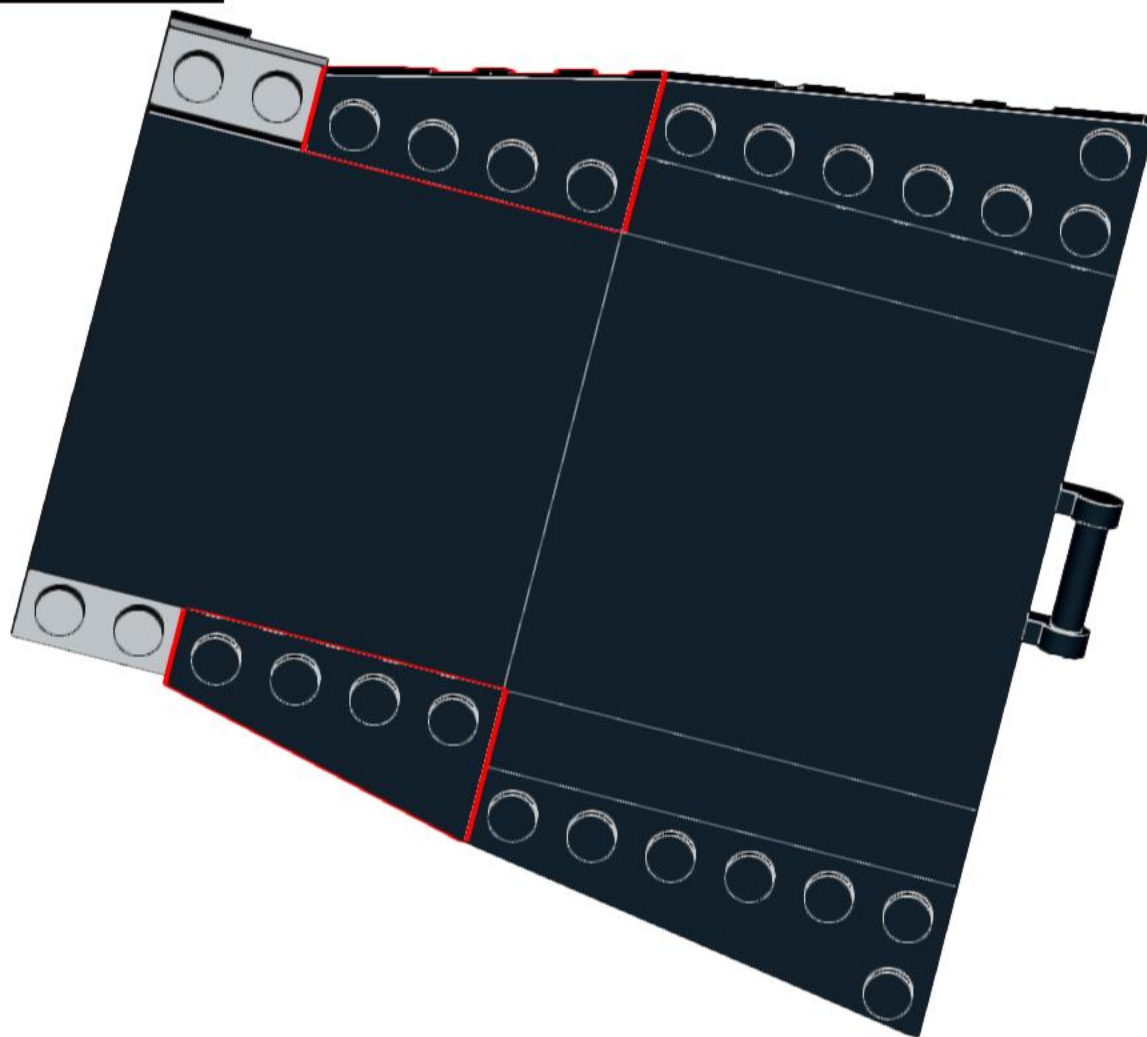
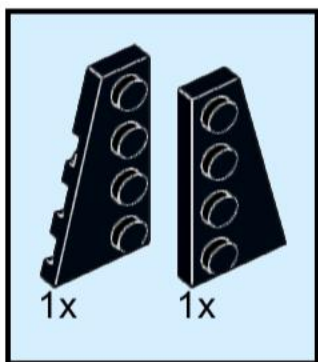

40

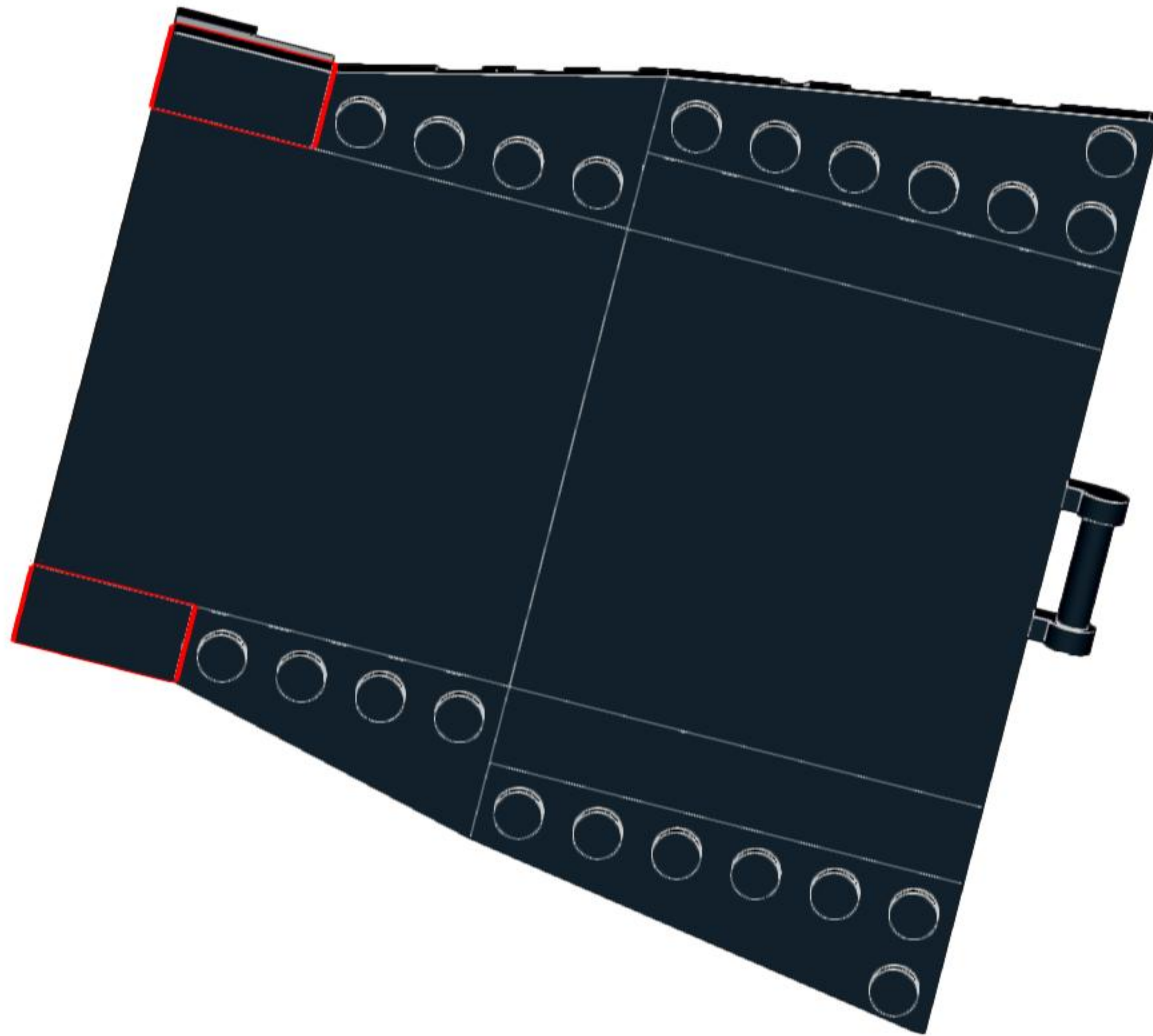
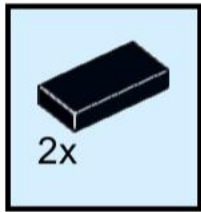

41

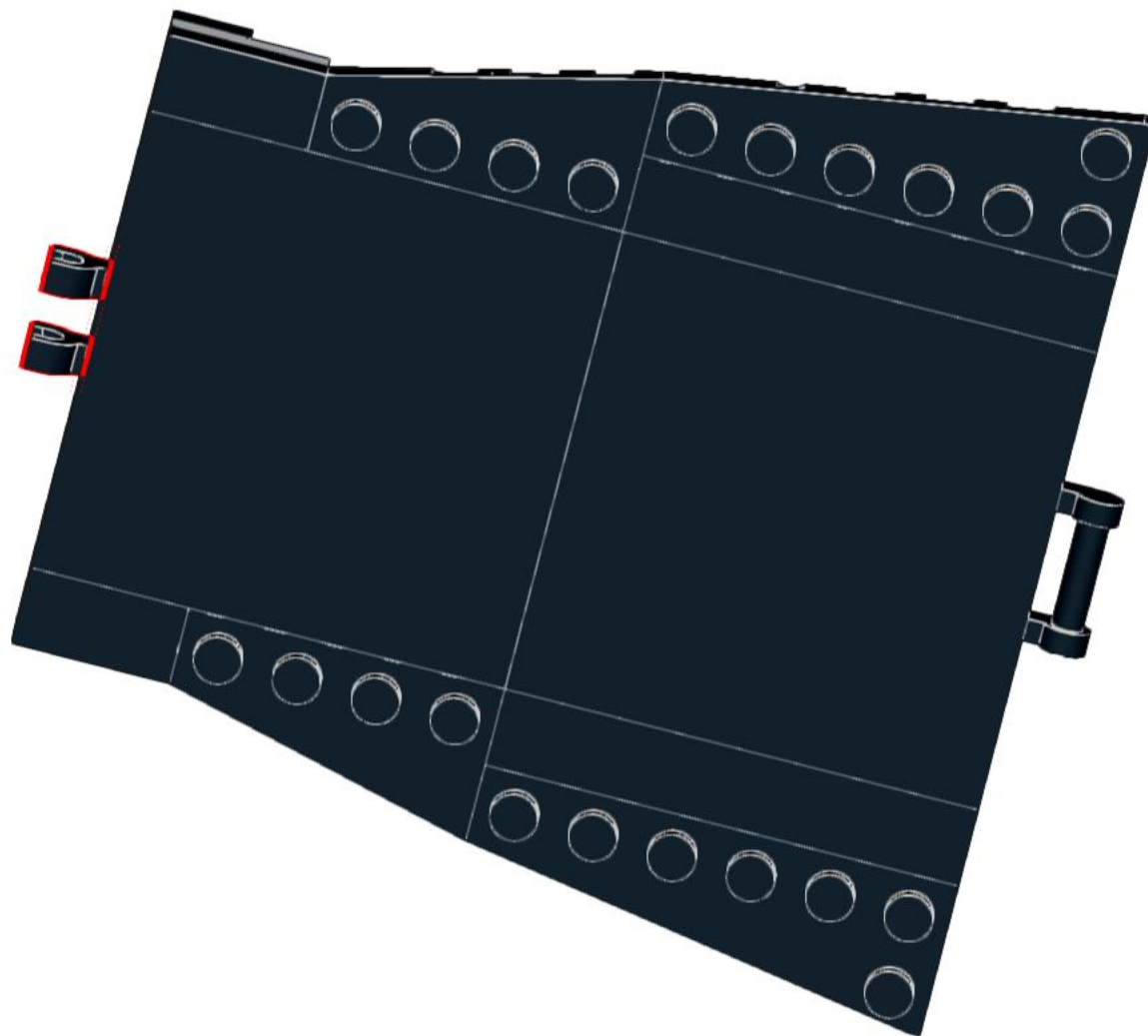
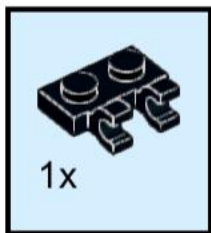

42

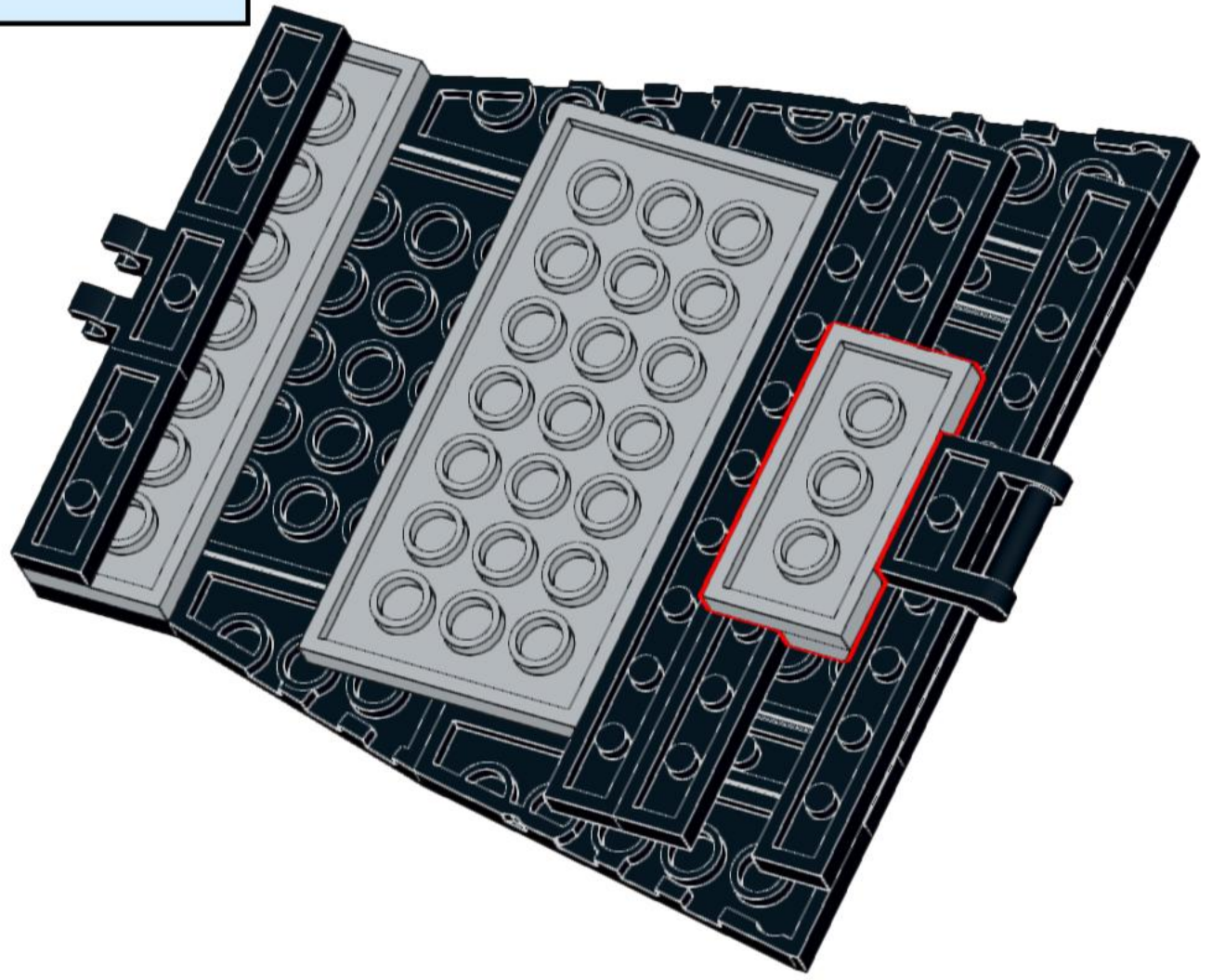
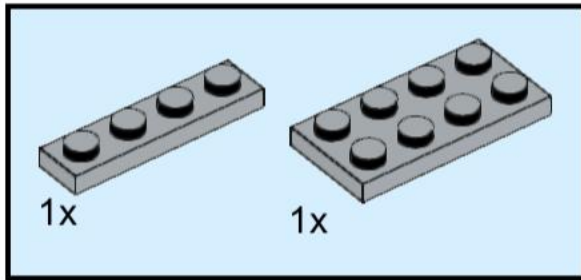

43

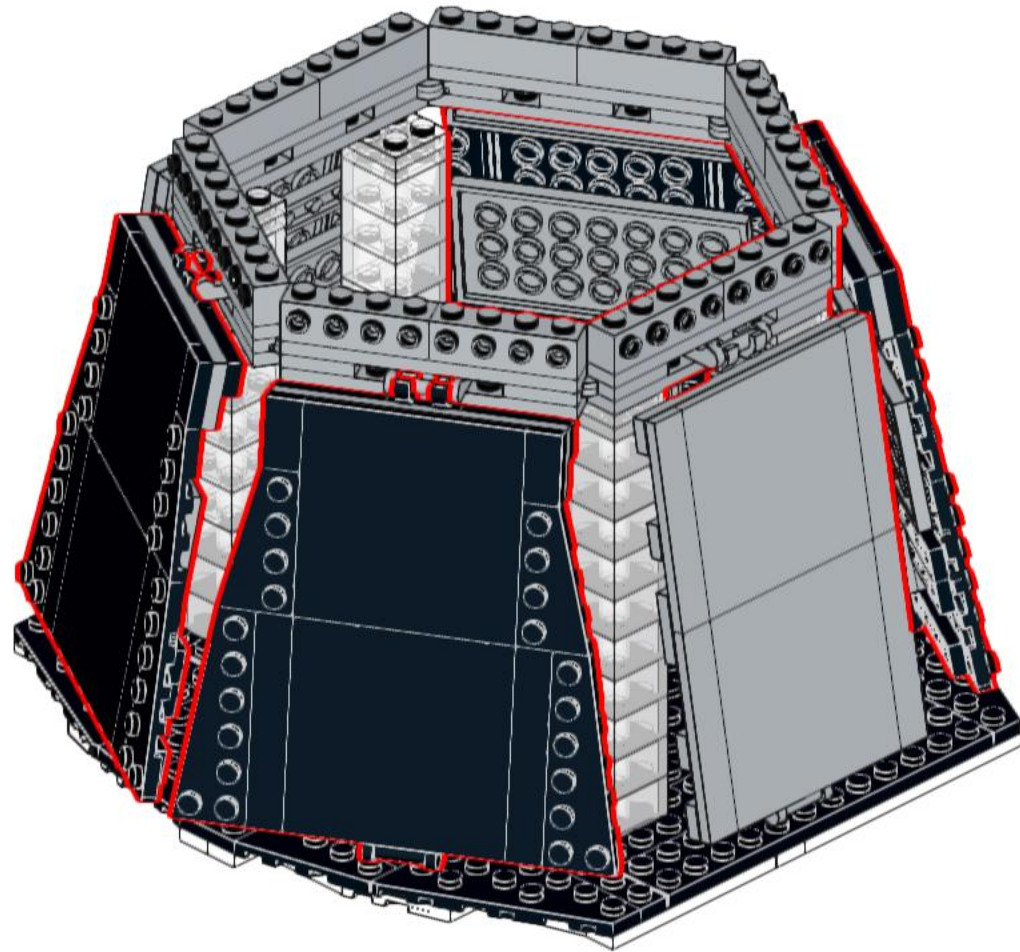

44

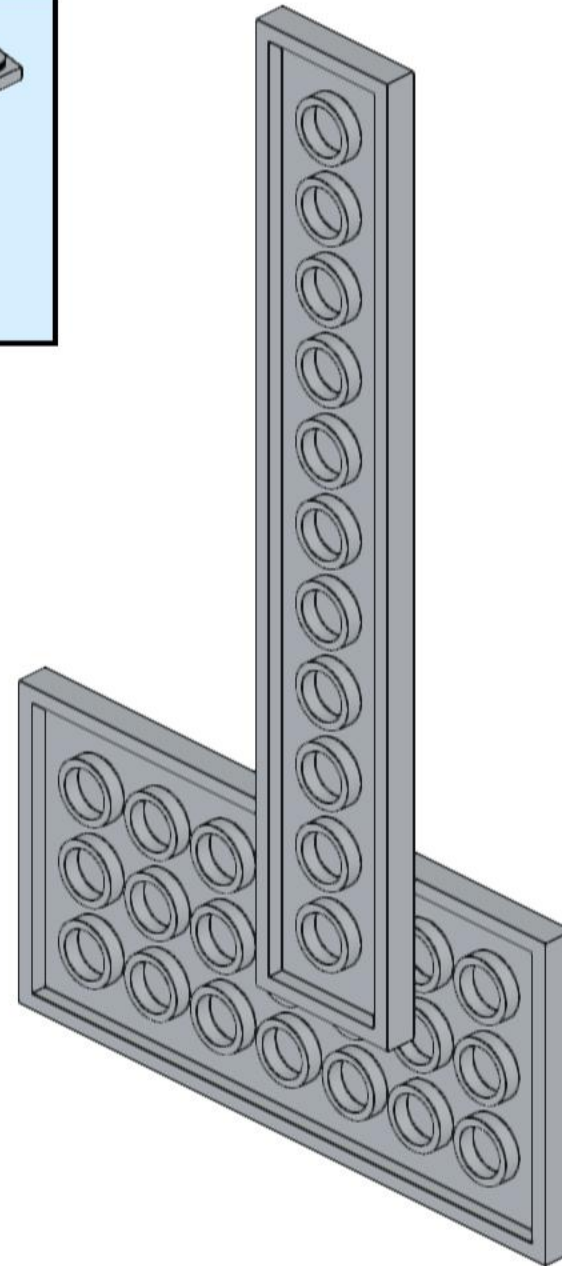
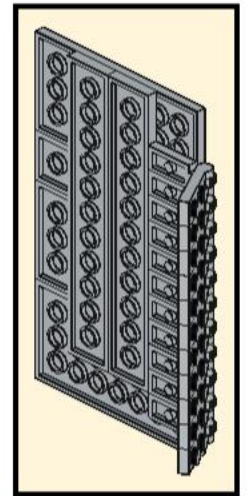
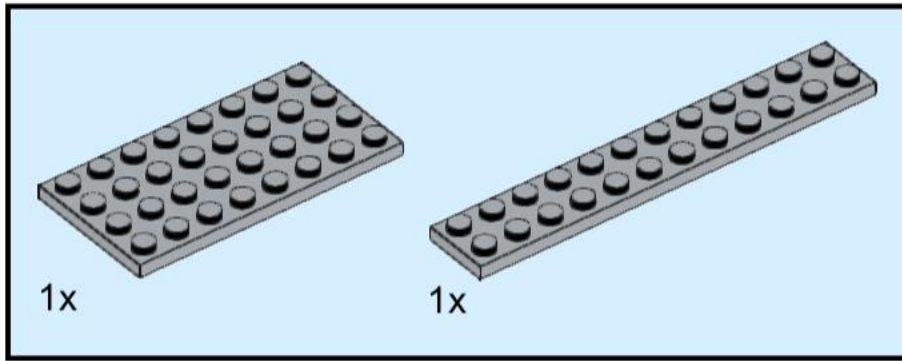

45

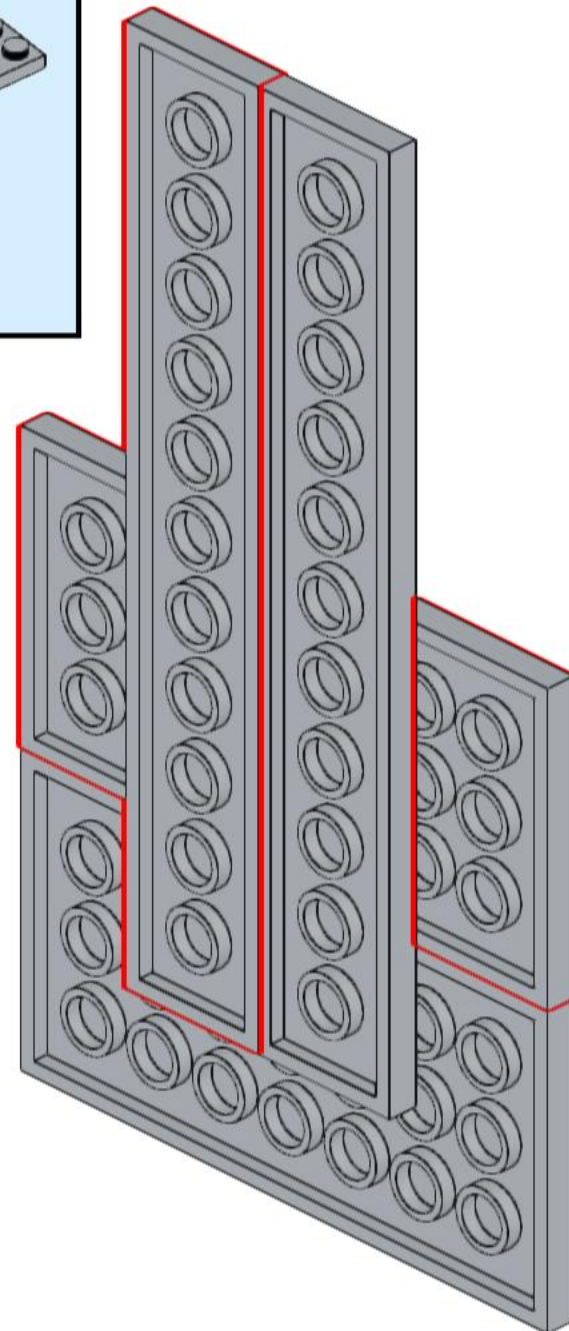
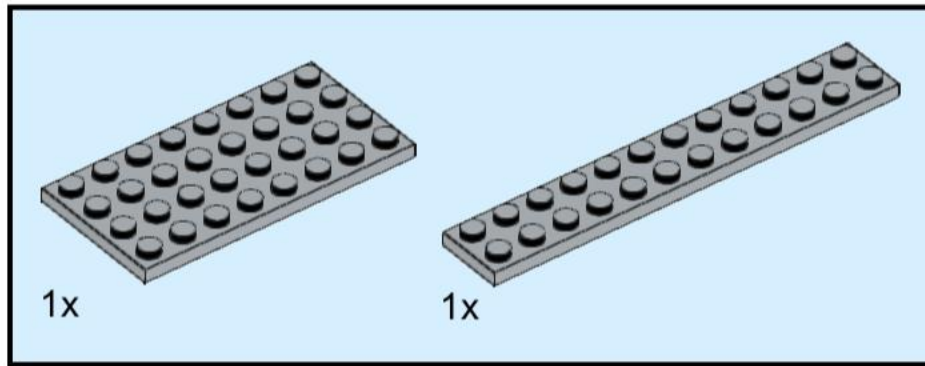

46

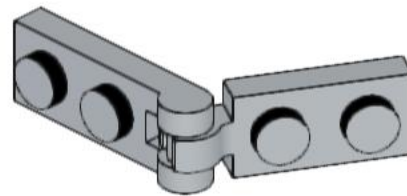
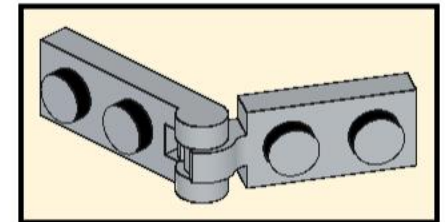
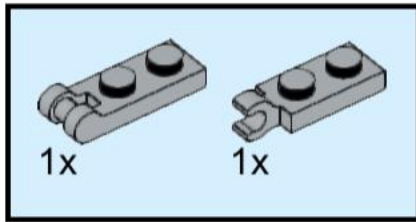

47

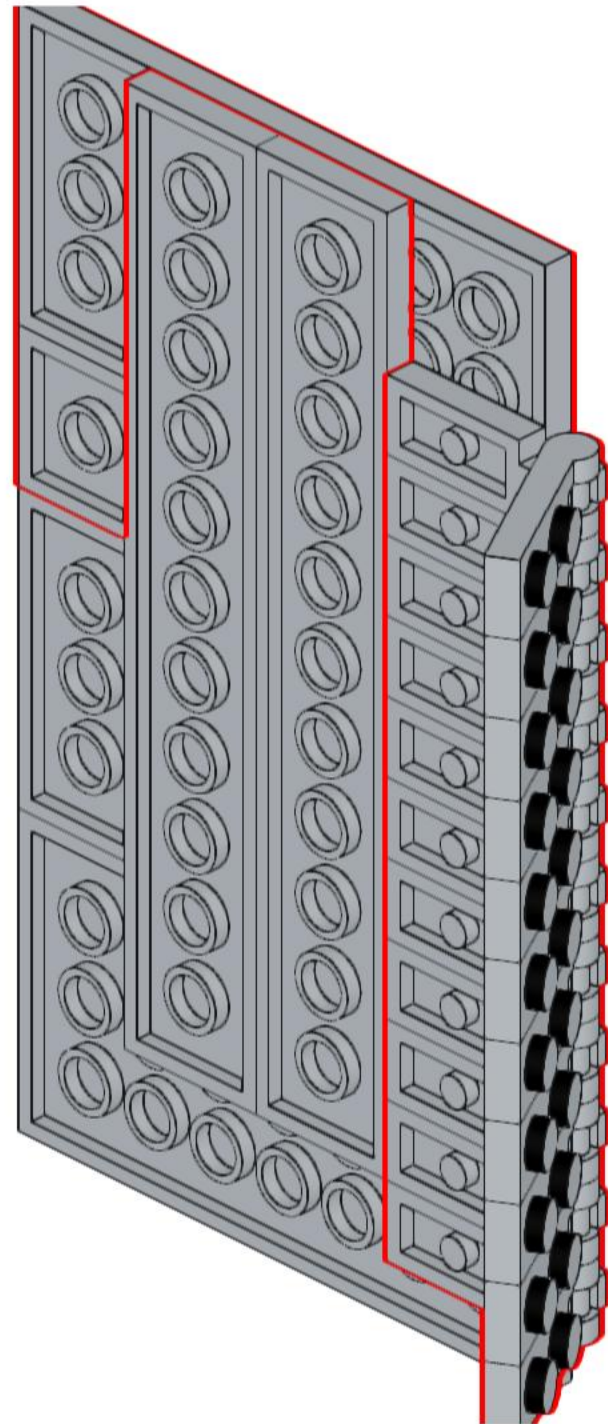
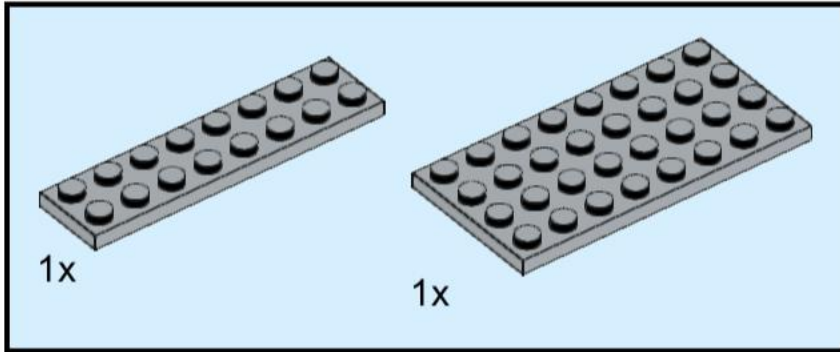

48

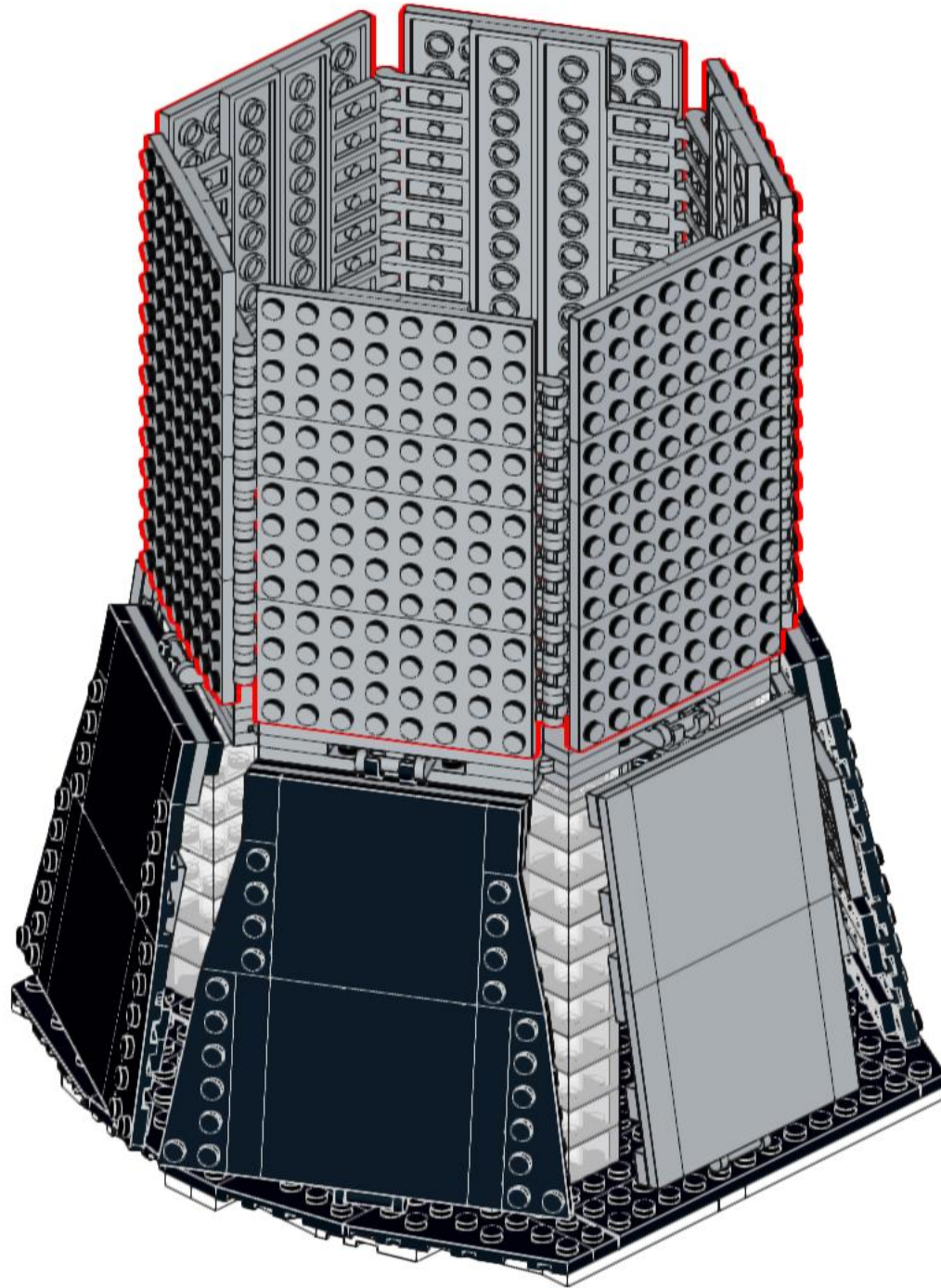

49

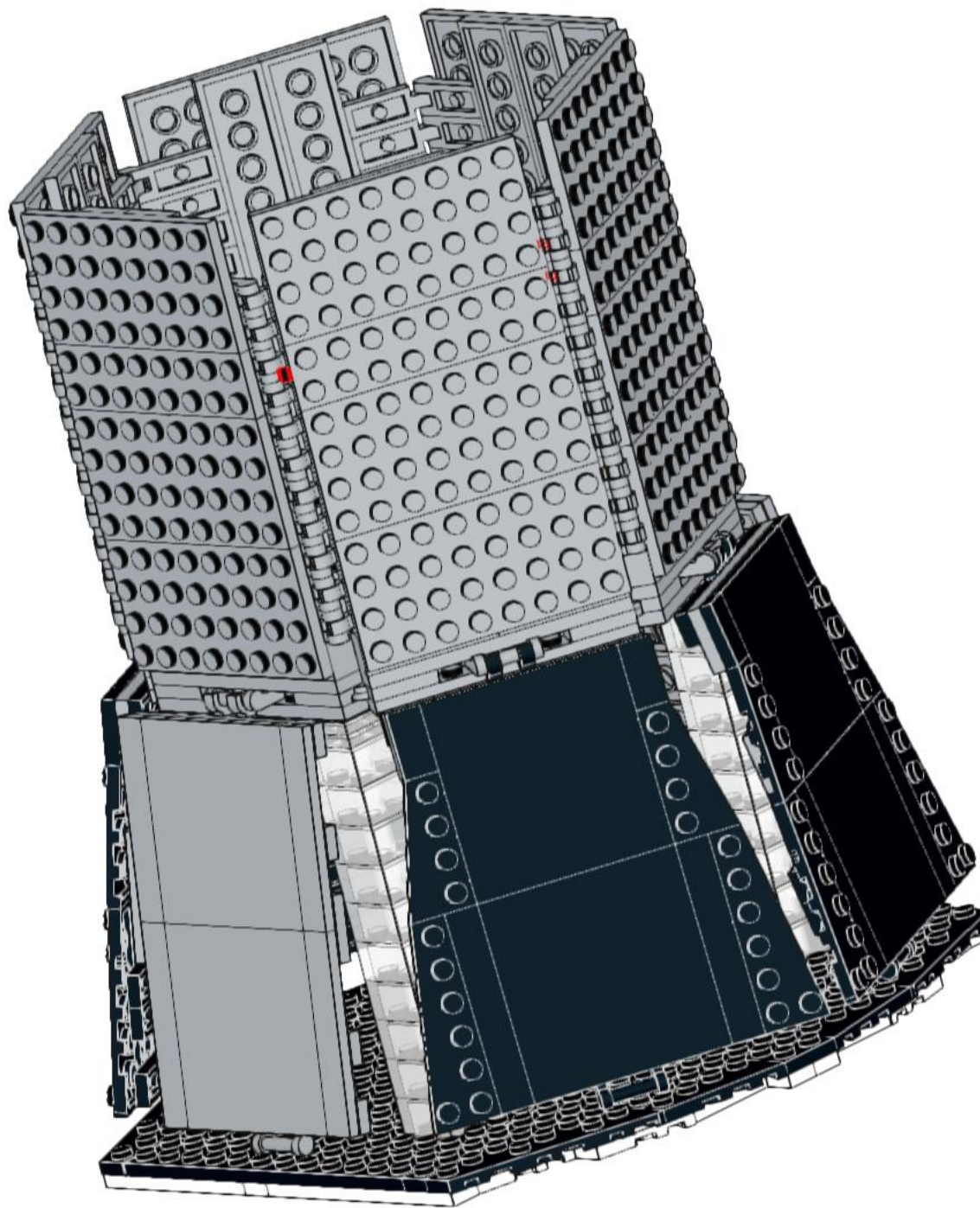

50

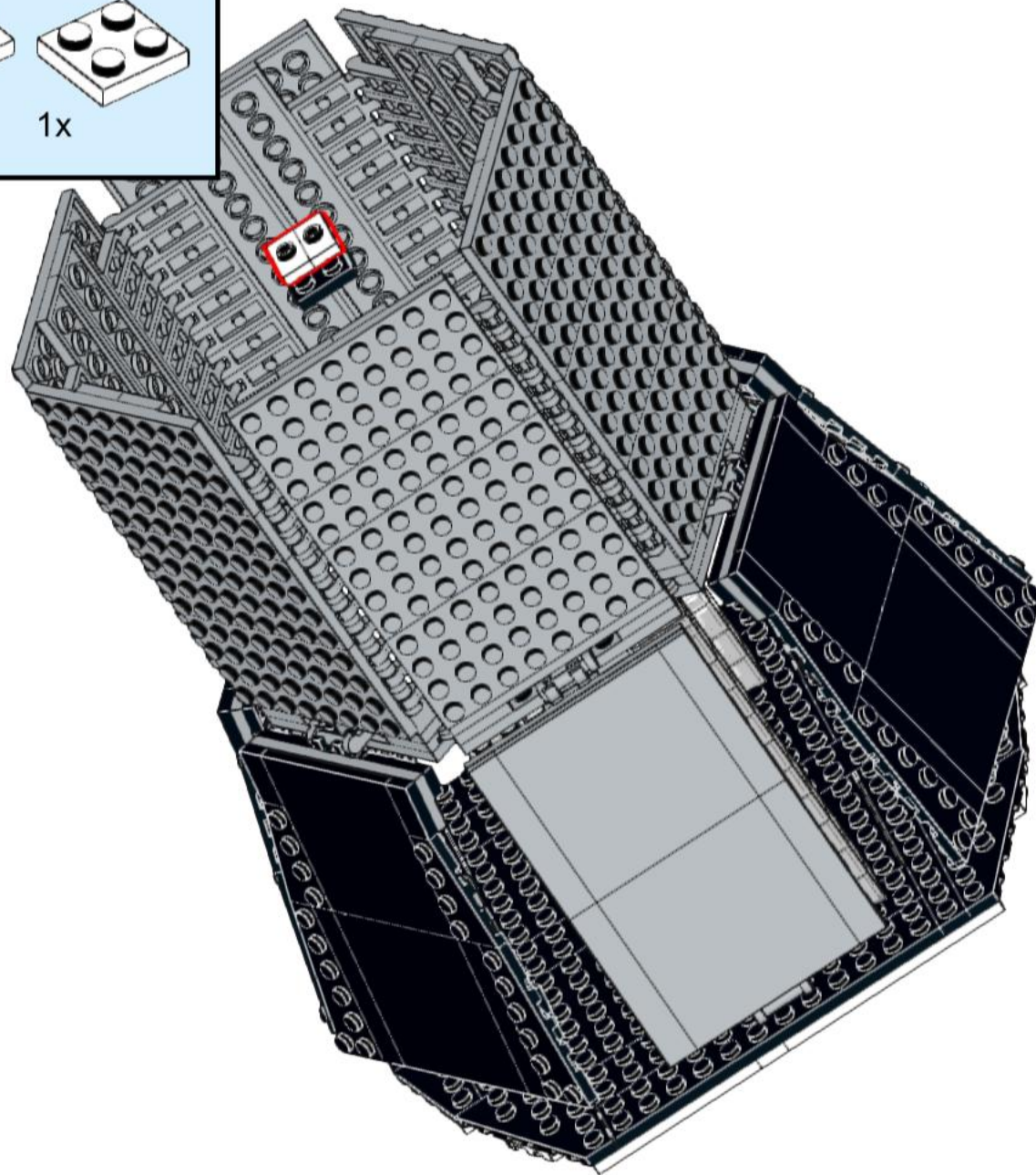
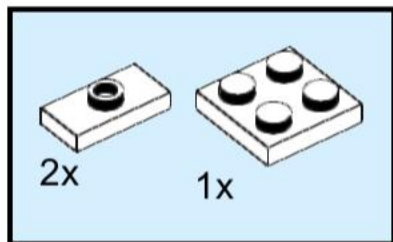

51

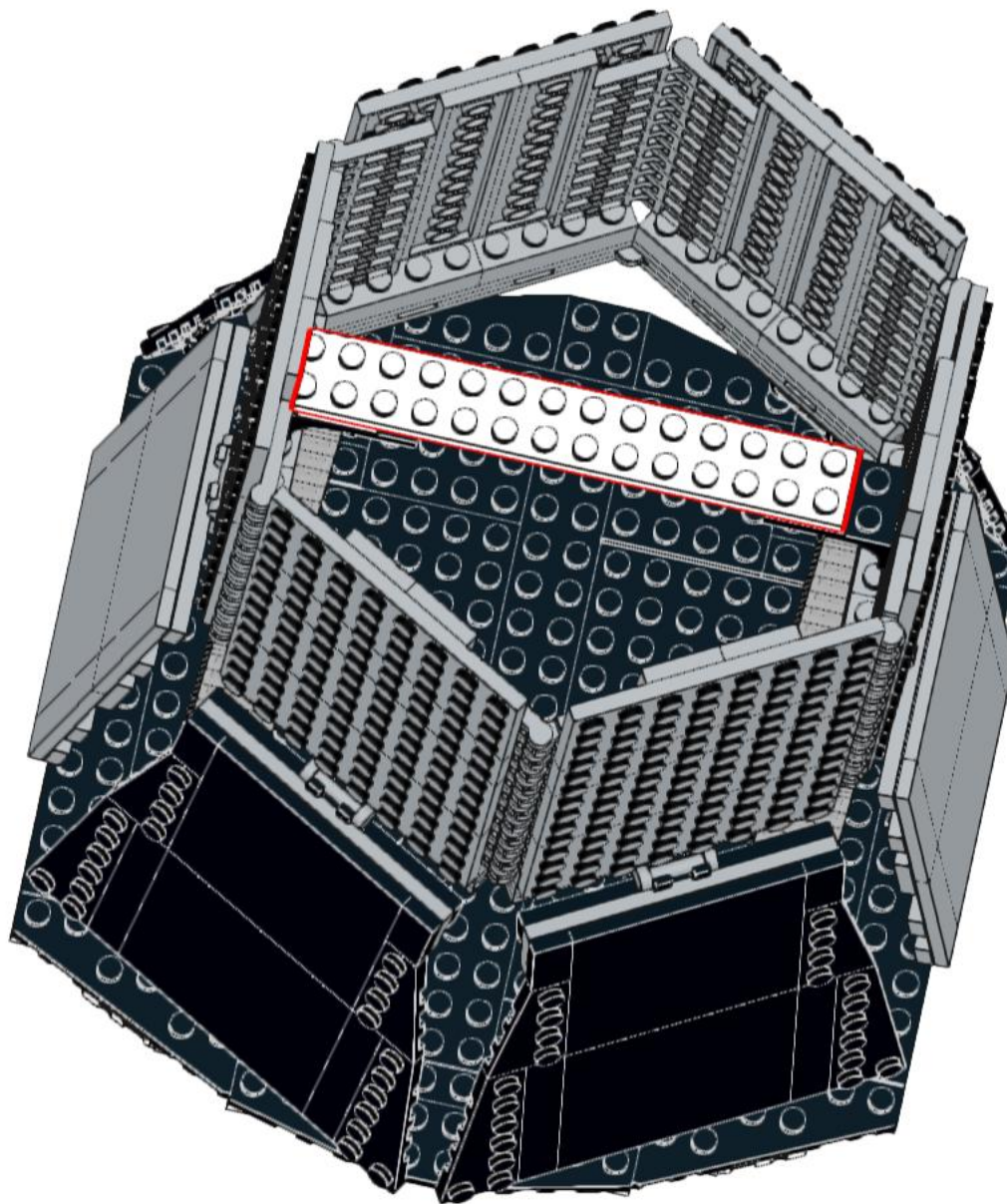
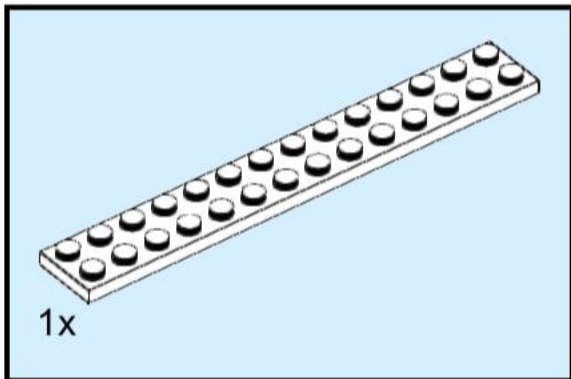

52

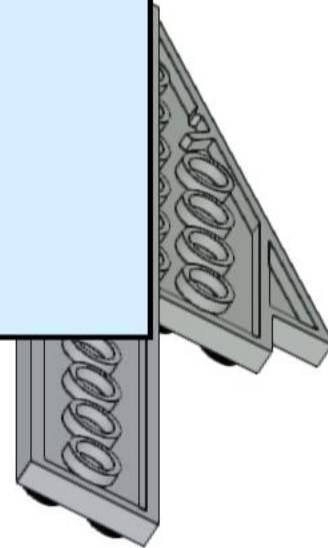
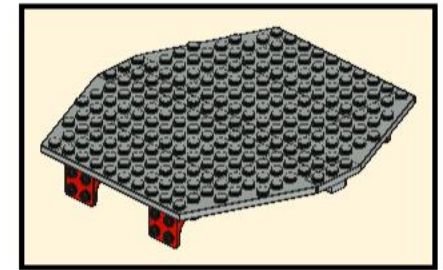
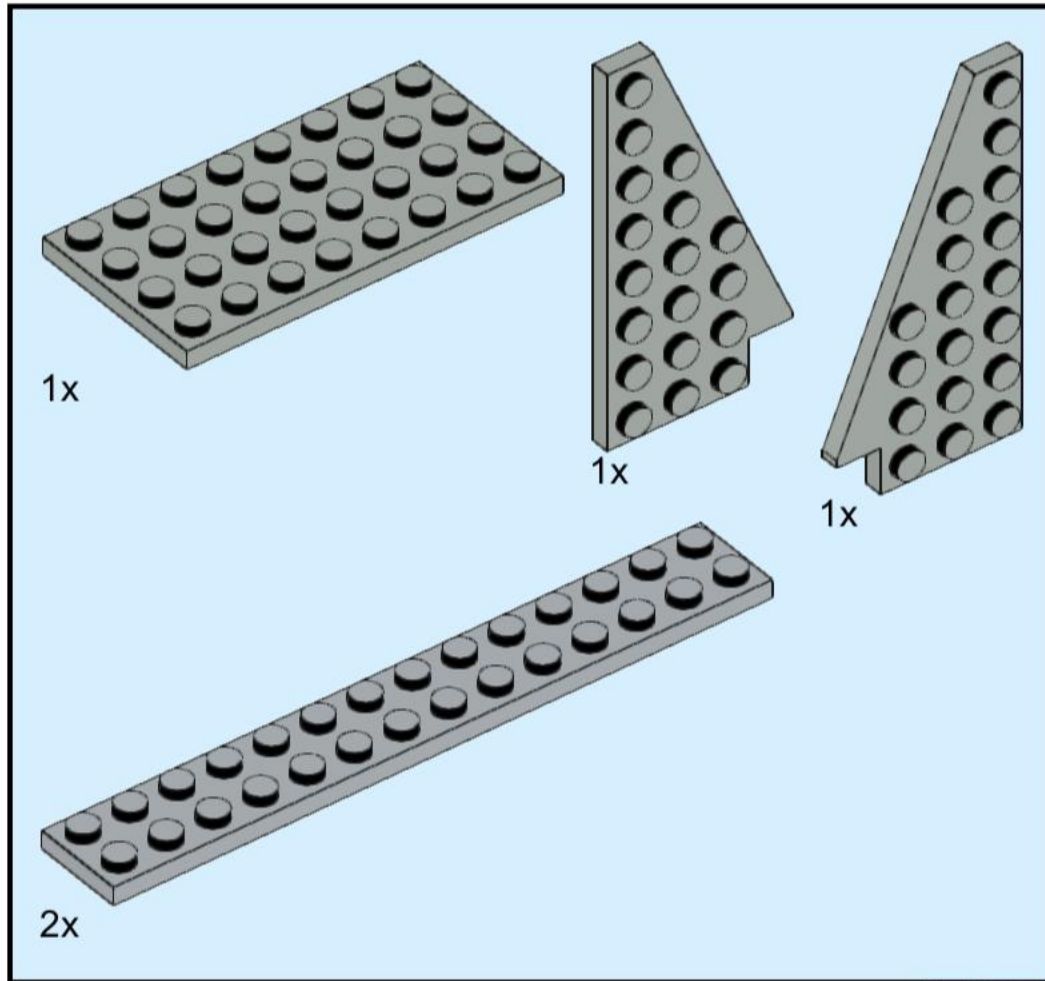

53

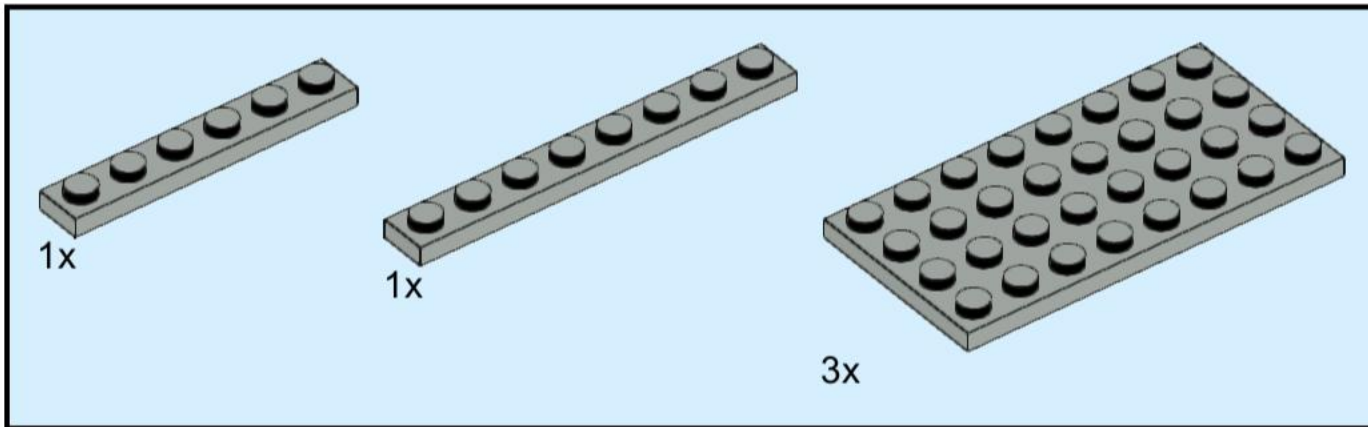

54

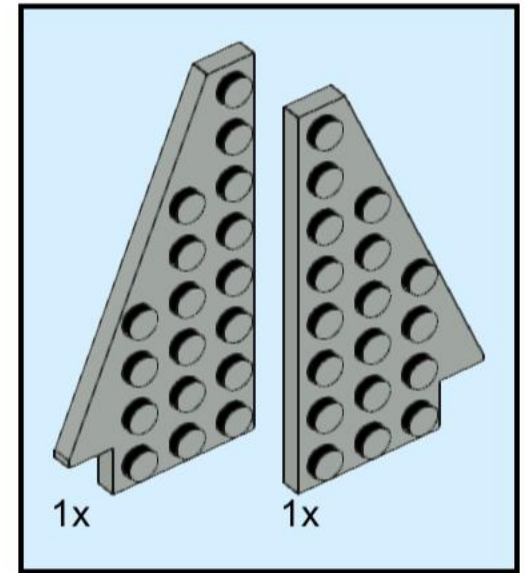
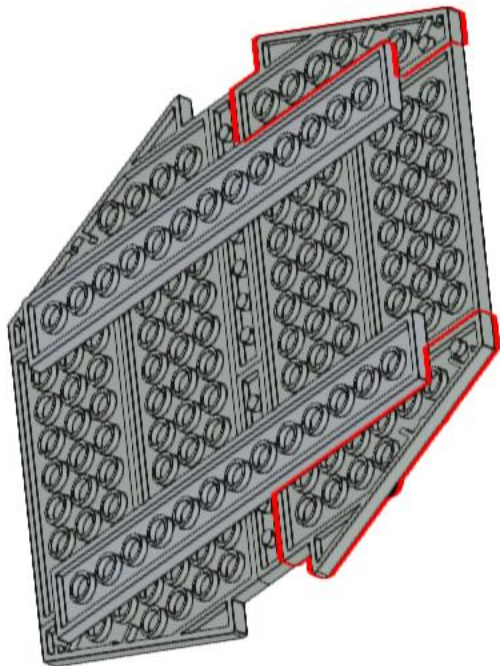

55

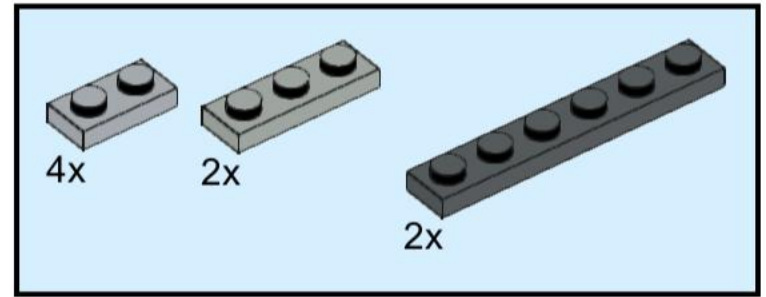

56

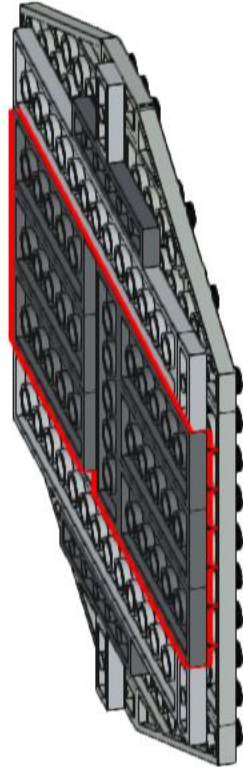
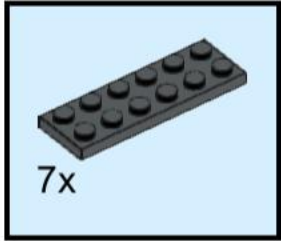

57

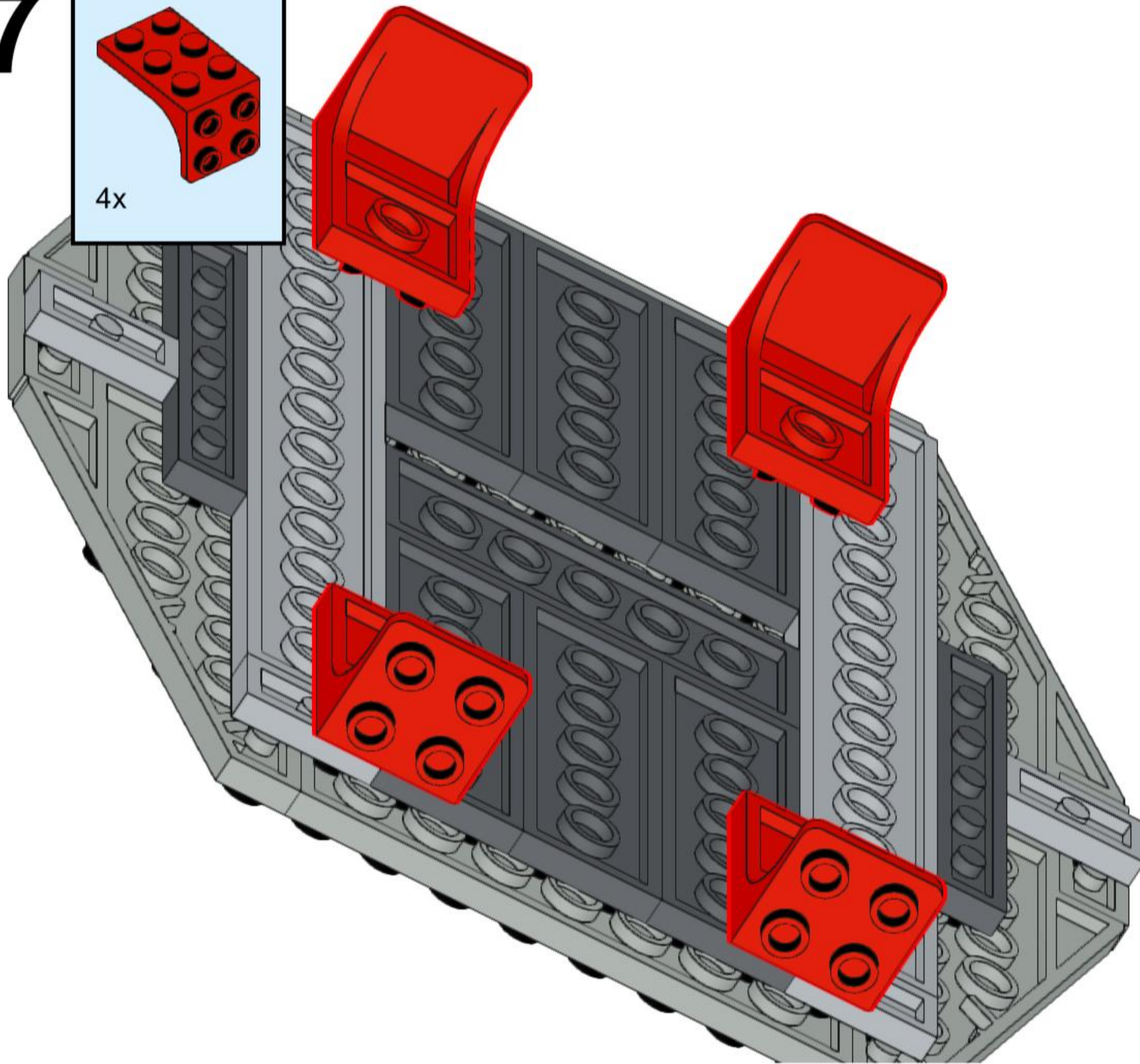
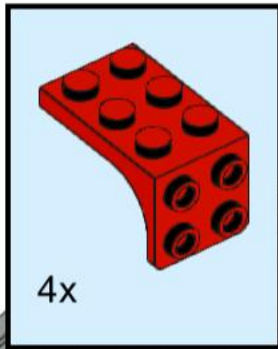

58

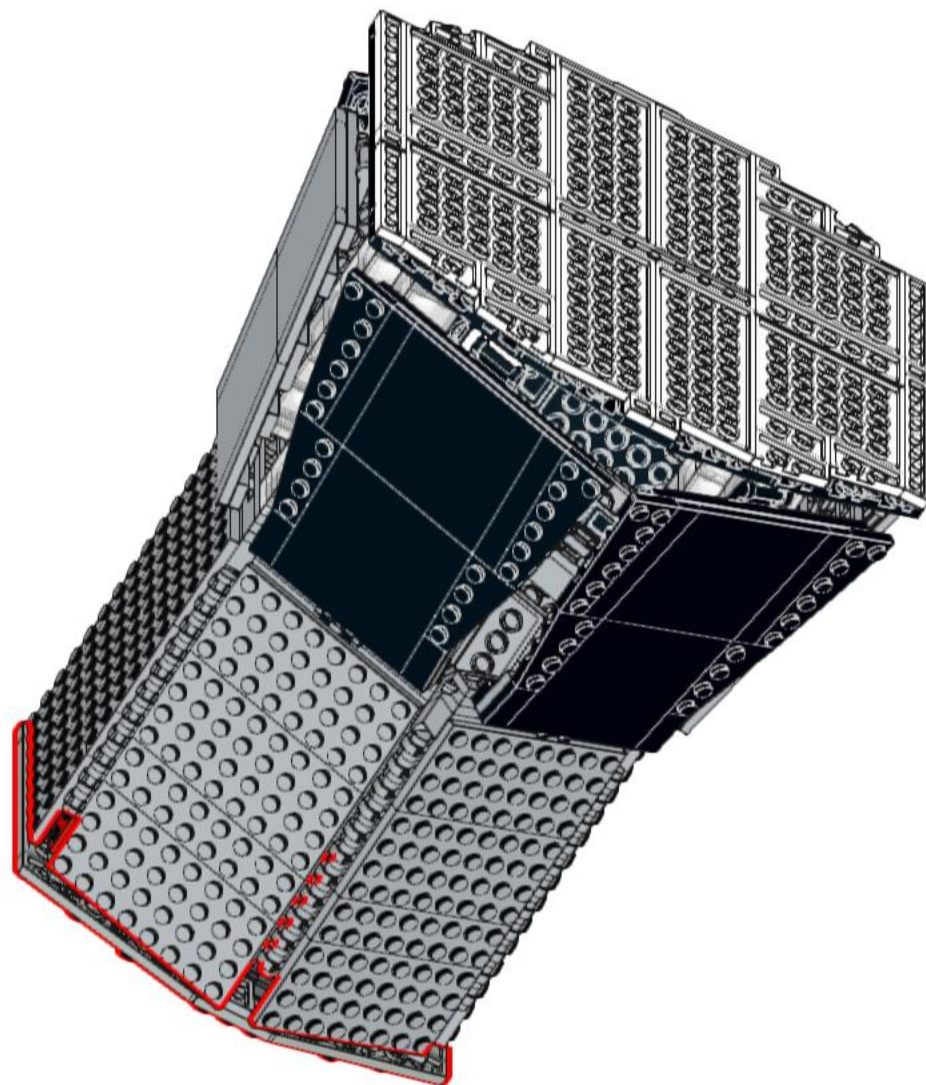

59

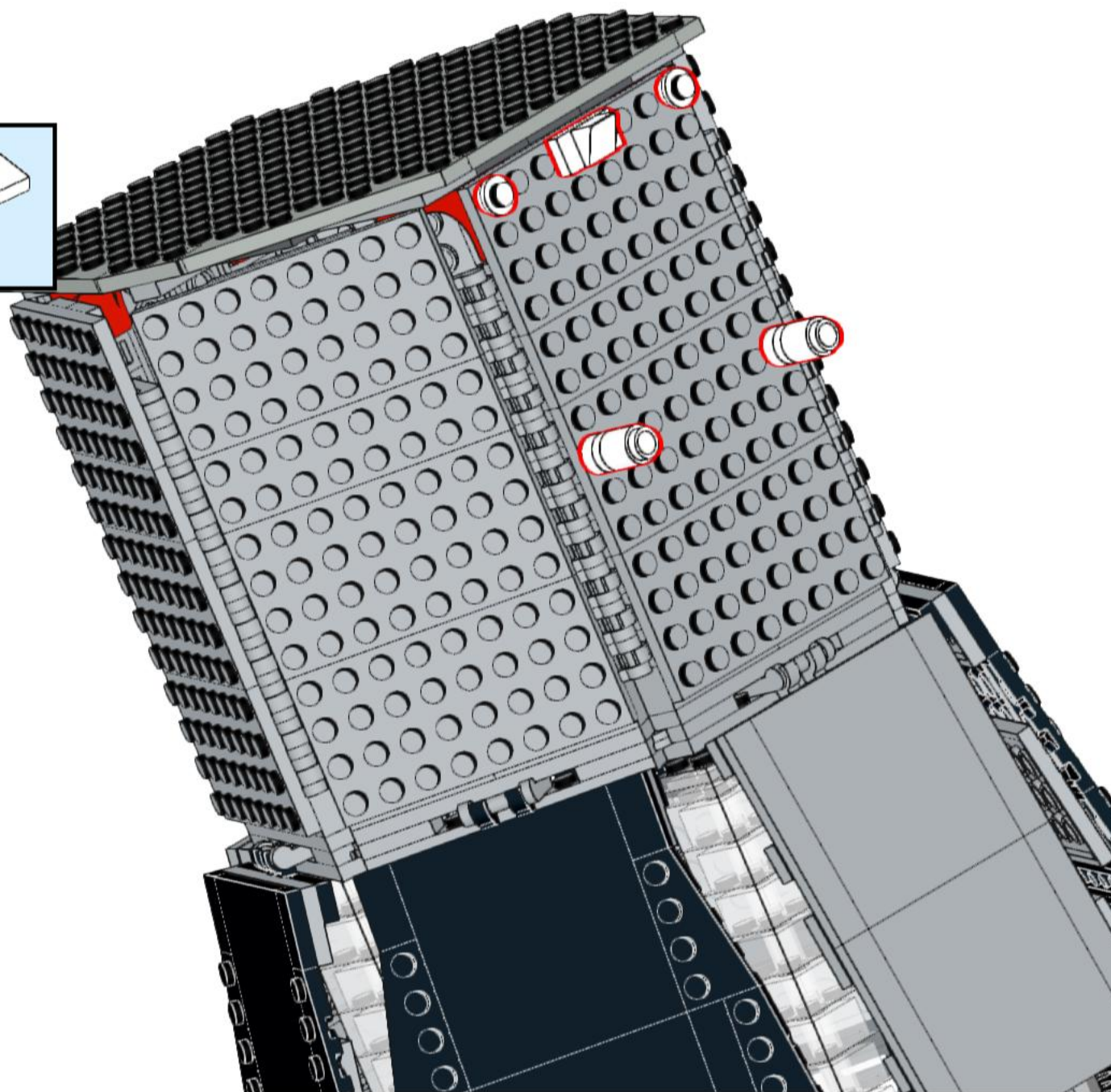
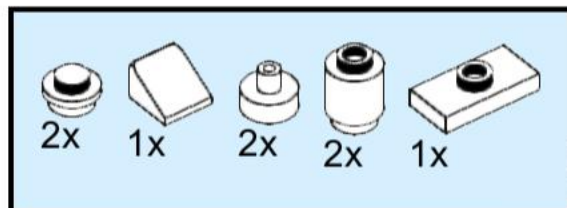

60

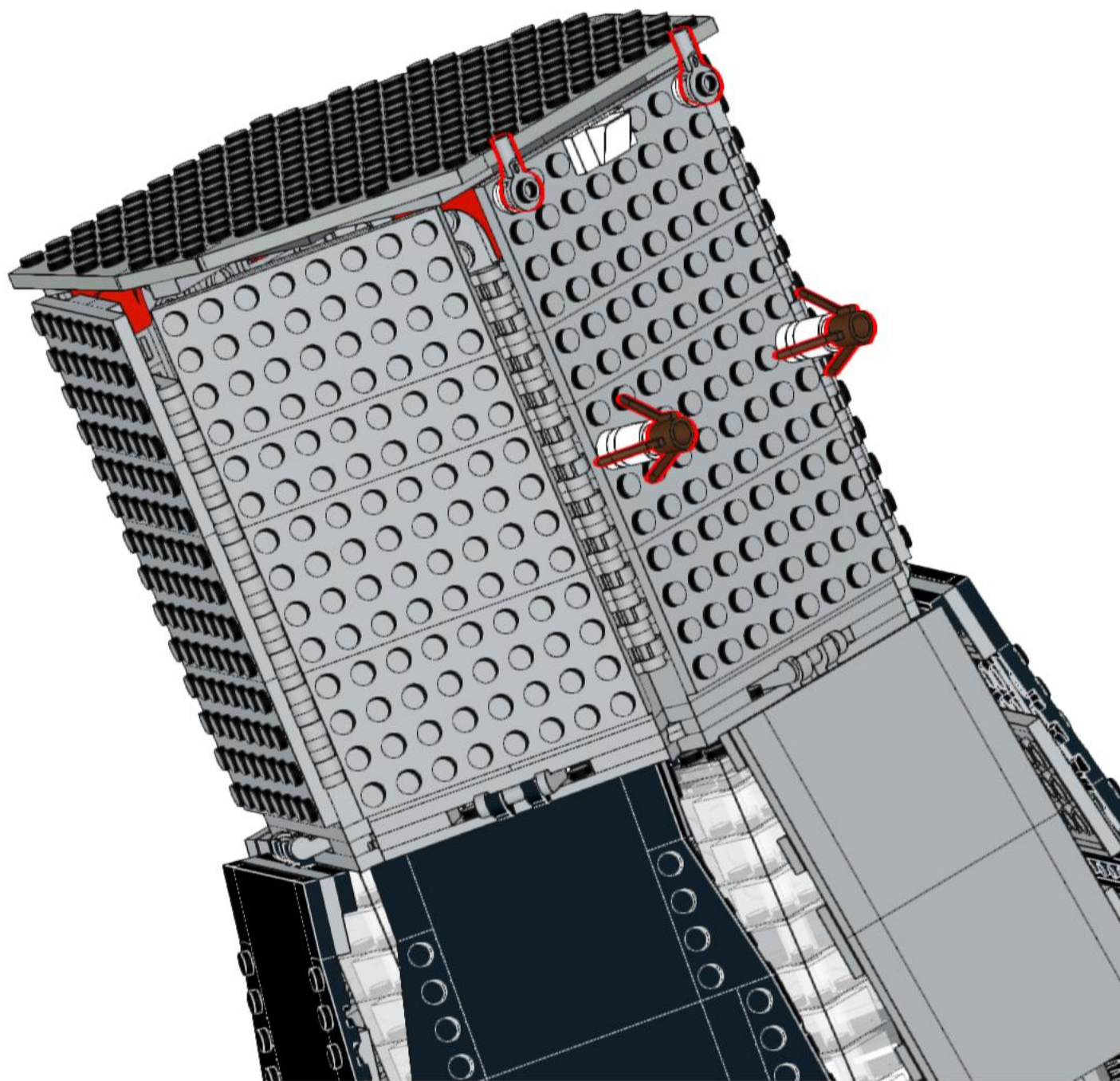
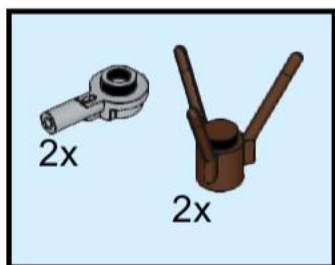

61

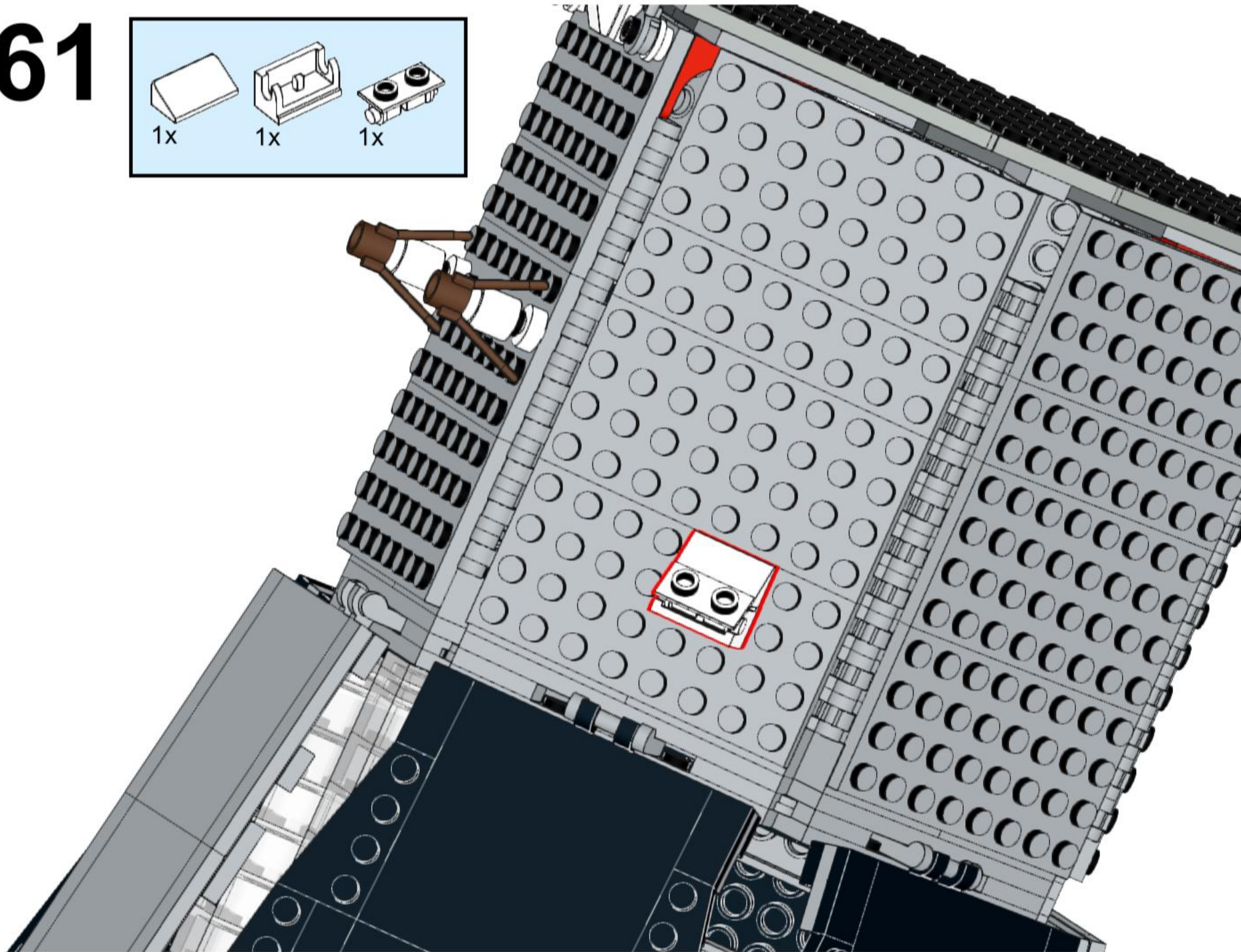
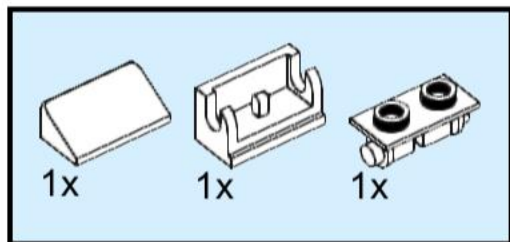

62

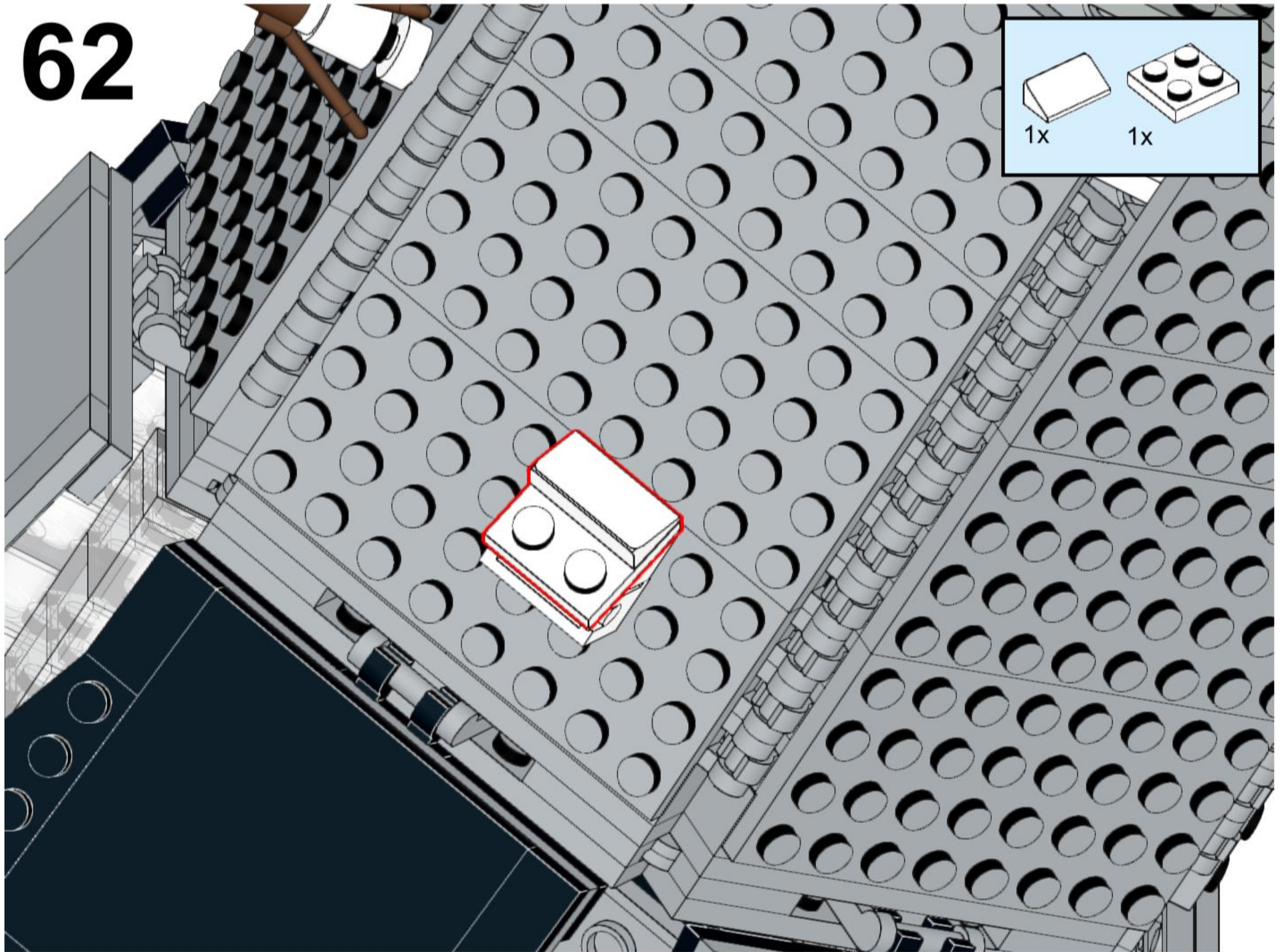
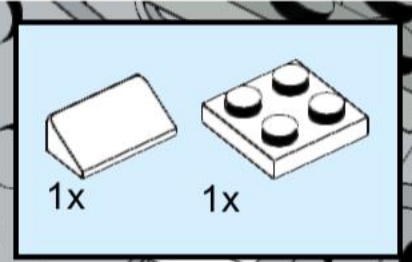

63

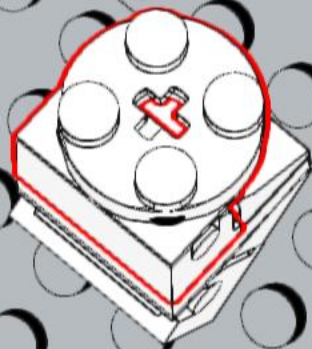
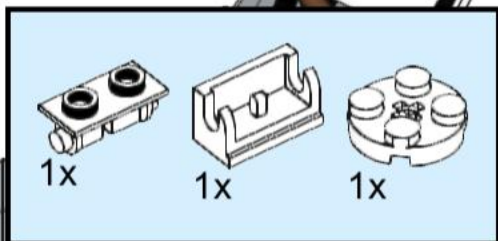

64

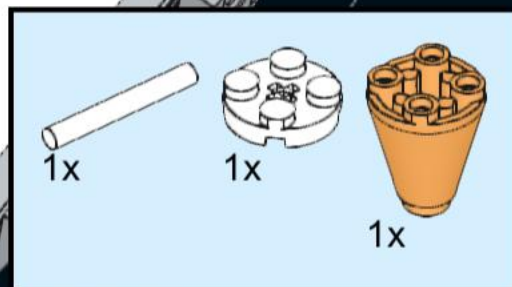
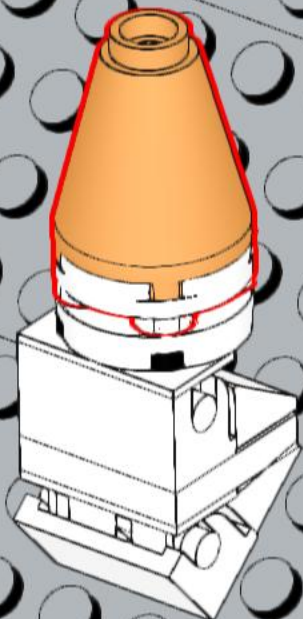

65

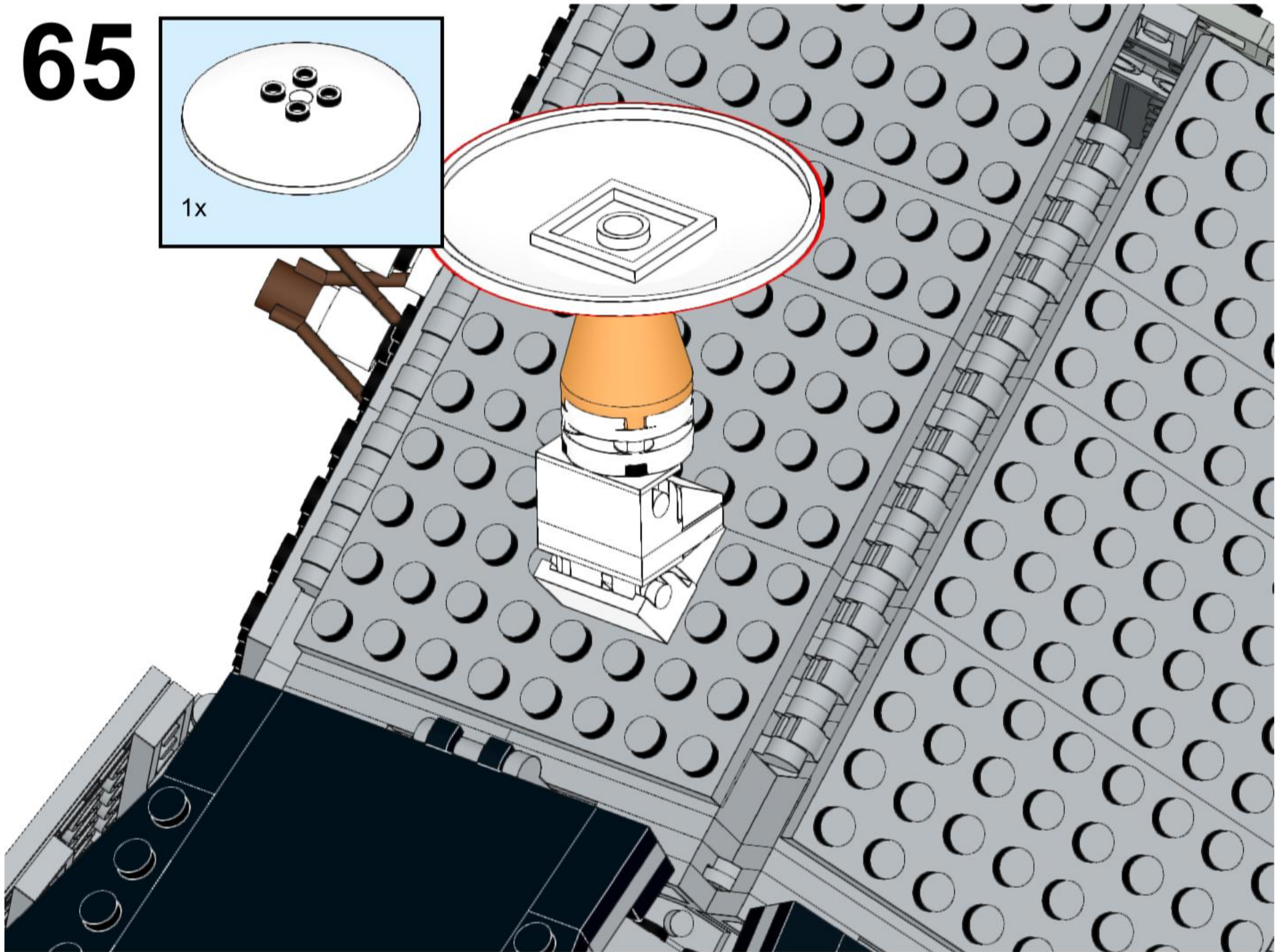
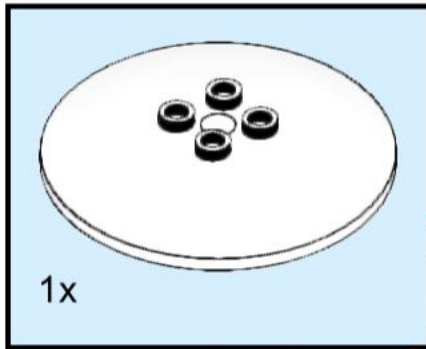

66

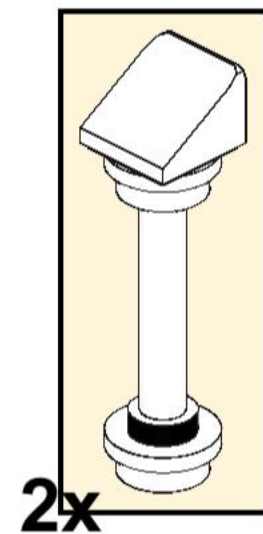
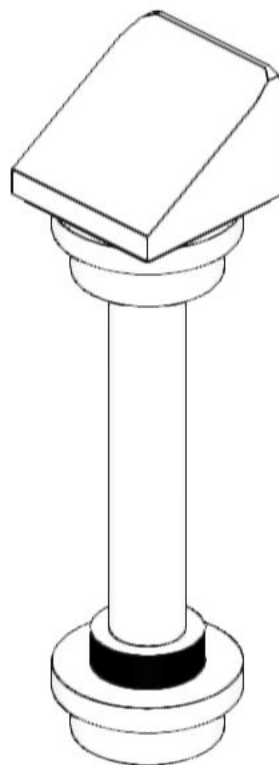
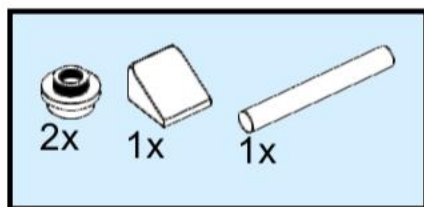

67

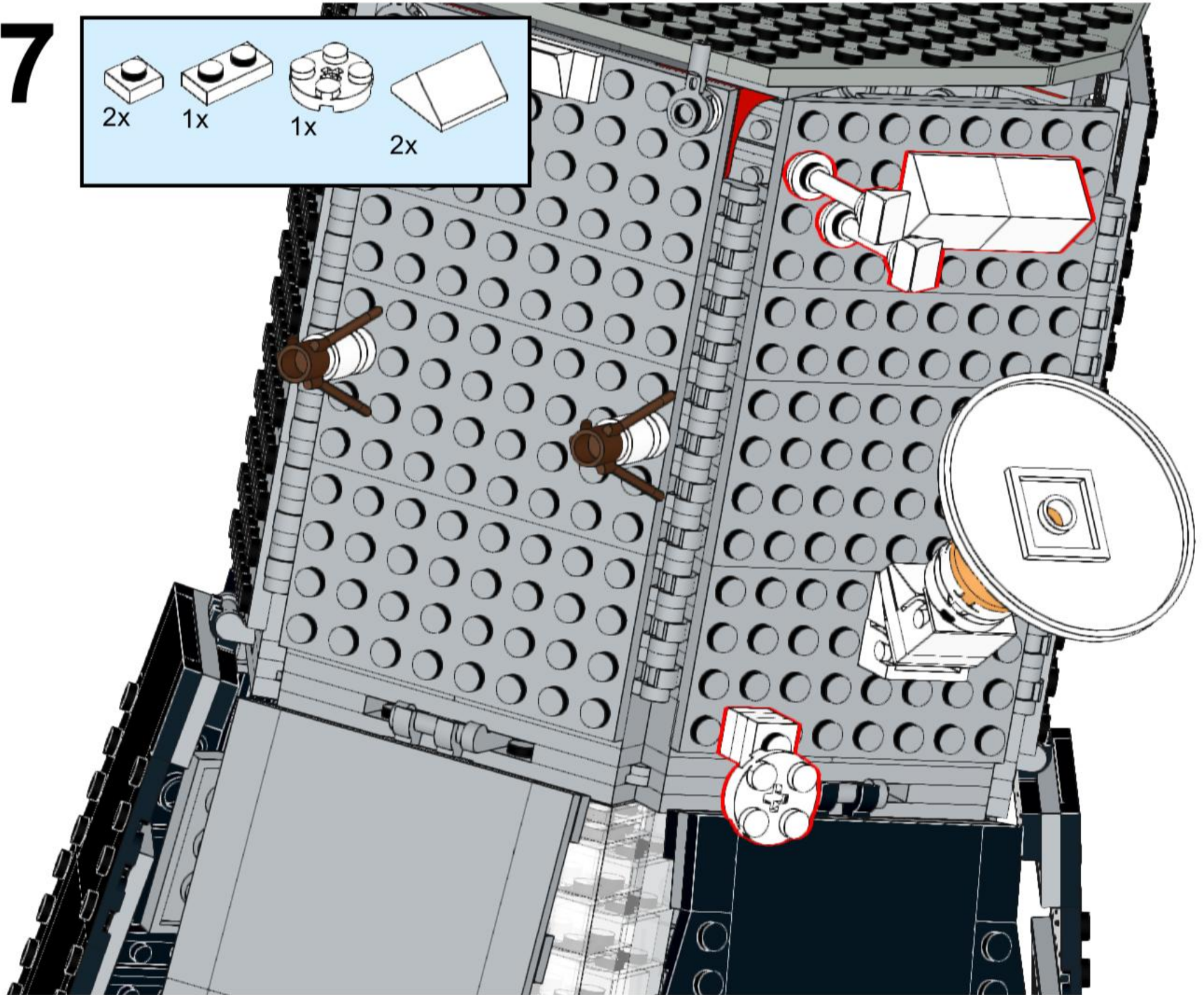
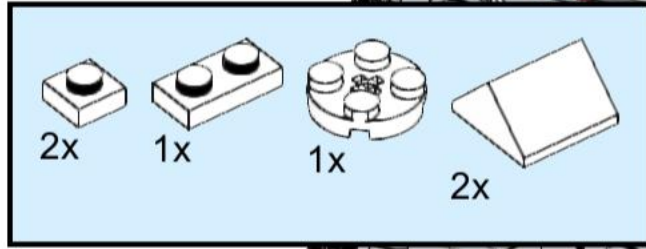

68

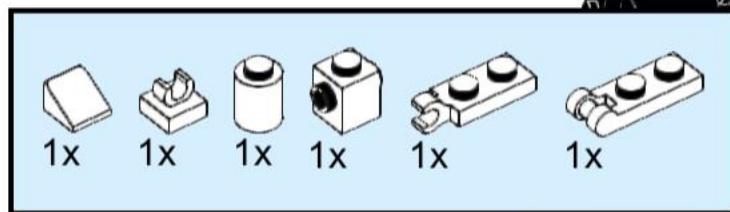
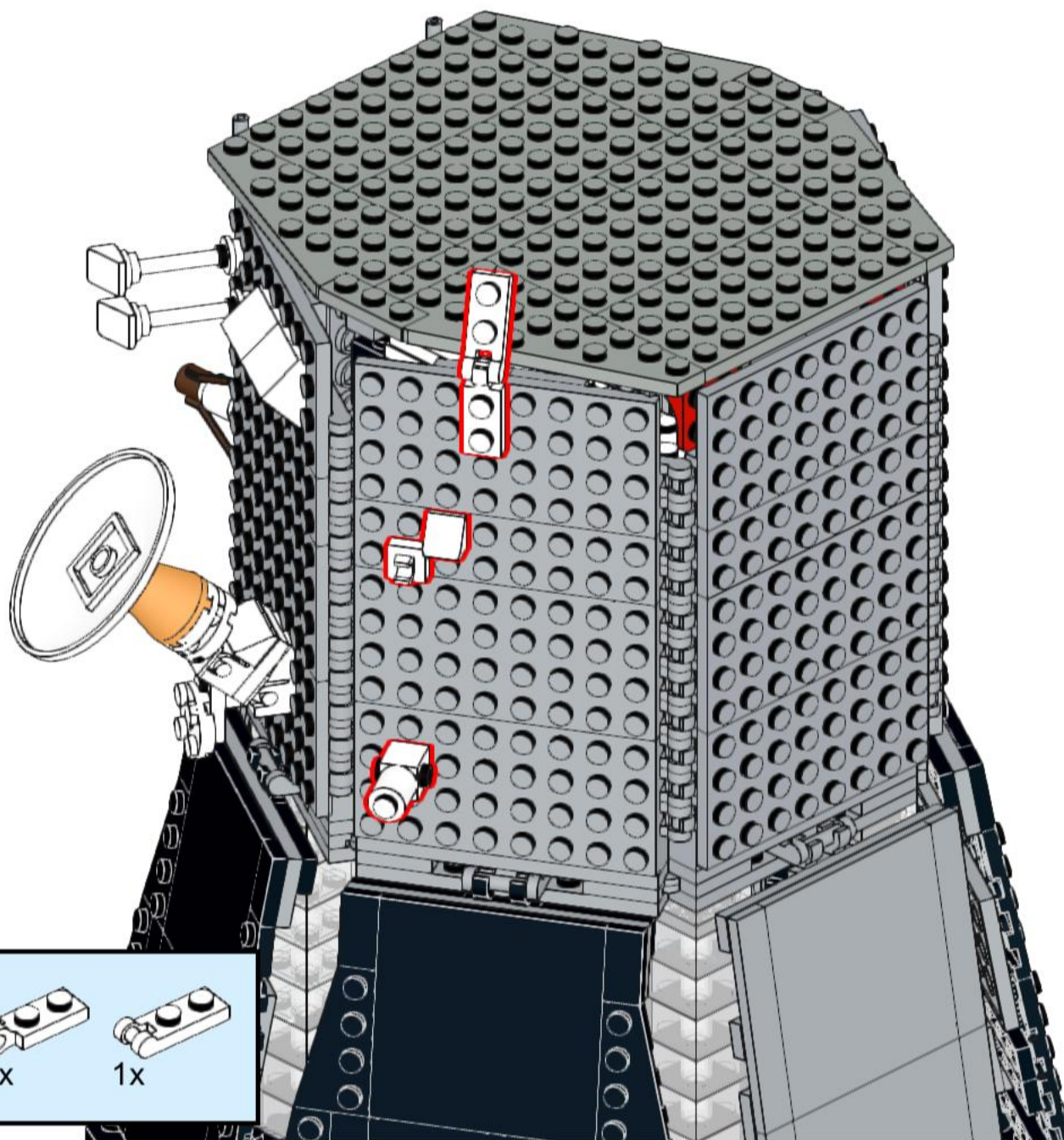

70

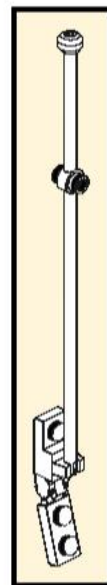
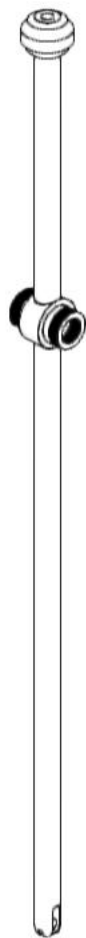
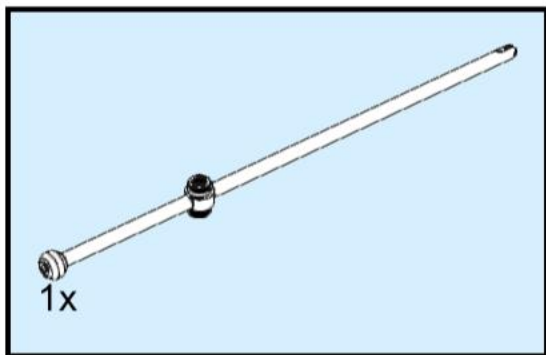

71

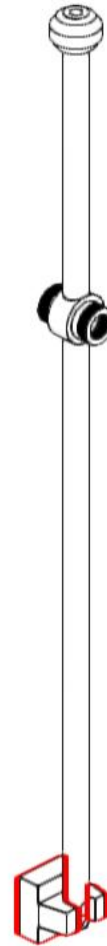
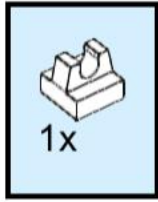

72

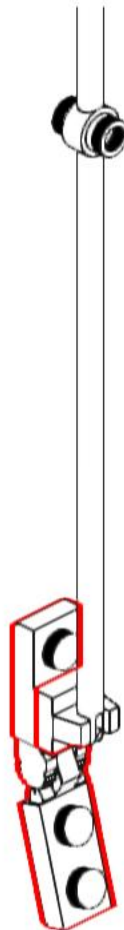
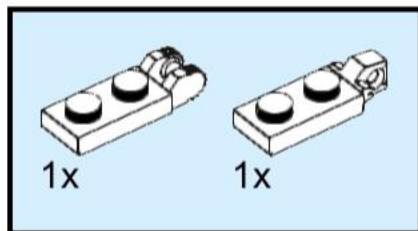

73

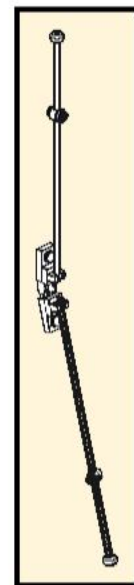
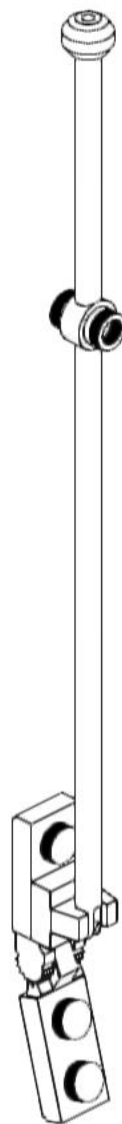

74

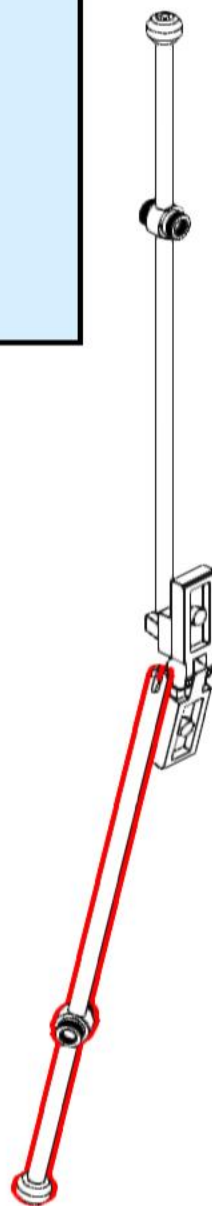
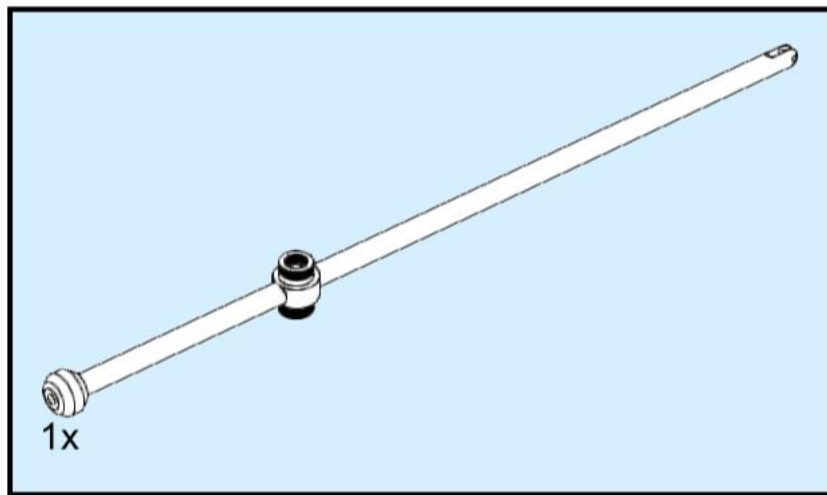

75

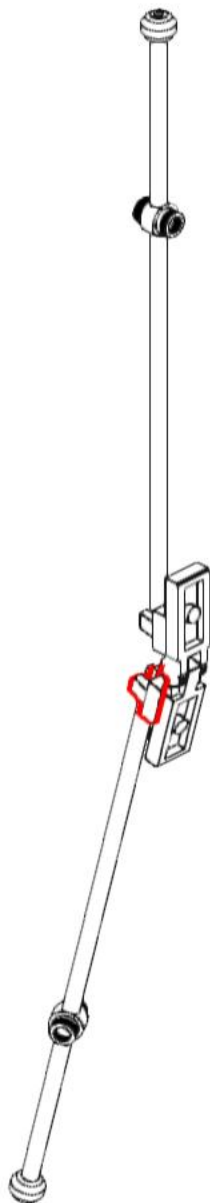
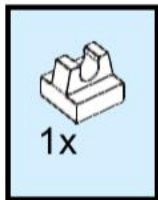

76

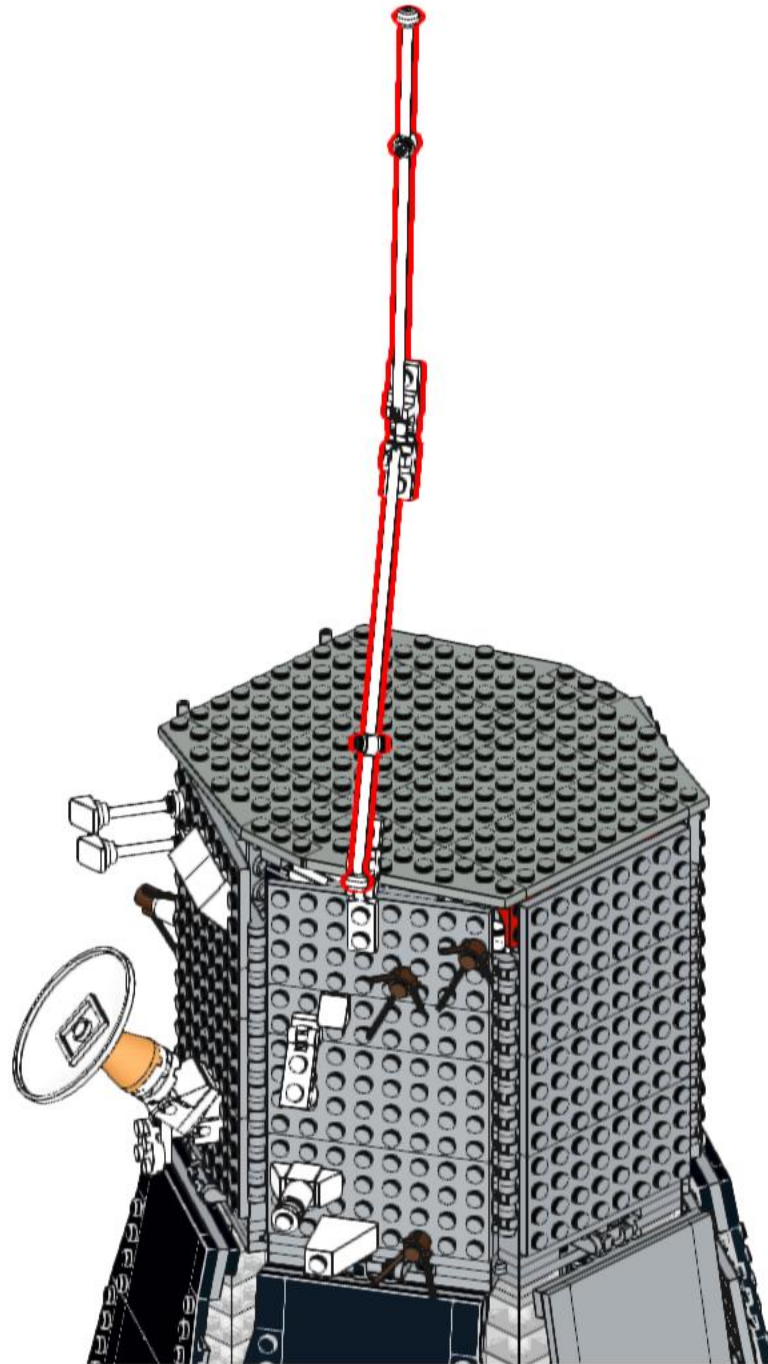

77

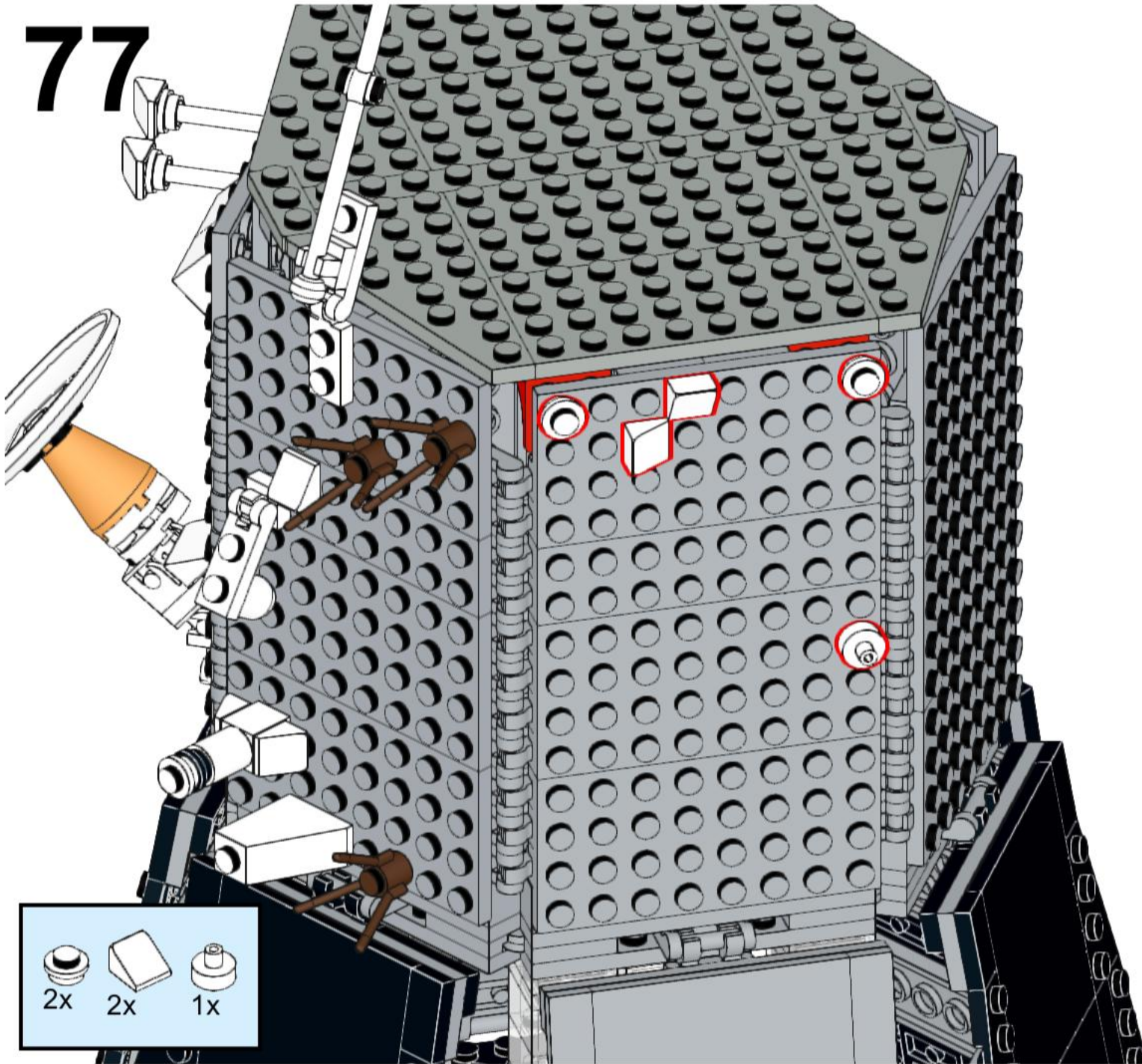

78

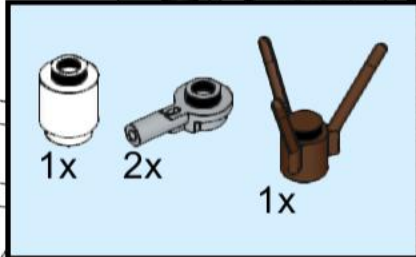

1x
2x
1x

This inset box lists the parts required for step 78: one white axle pin, two grey axle pins, and one brown axle pin.

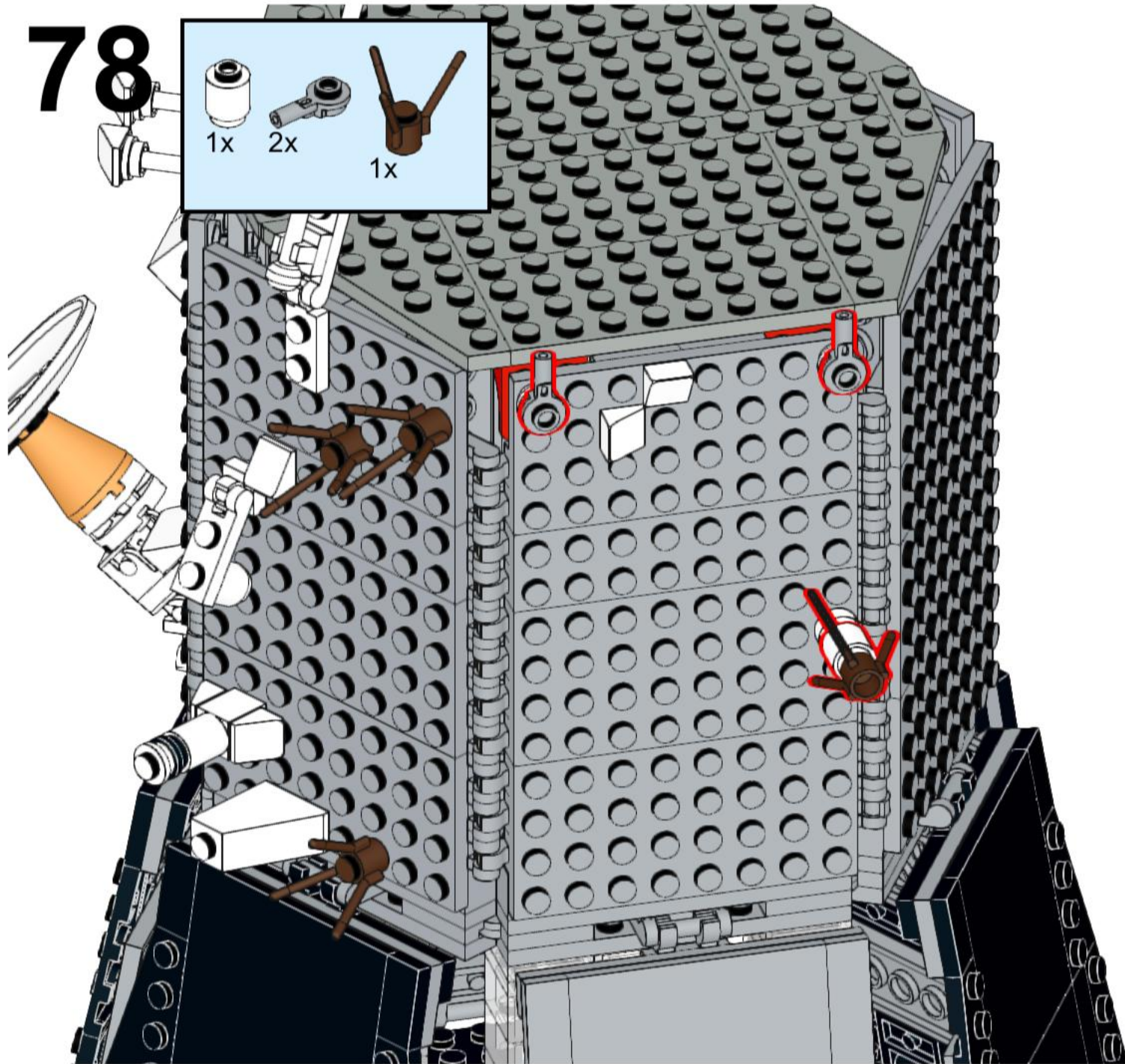

79

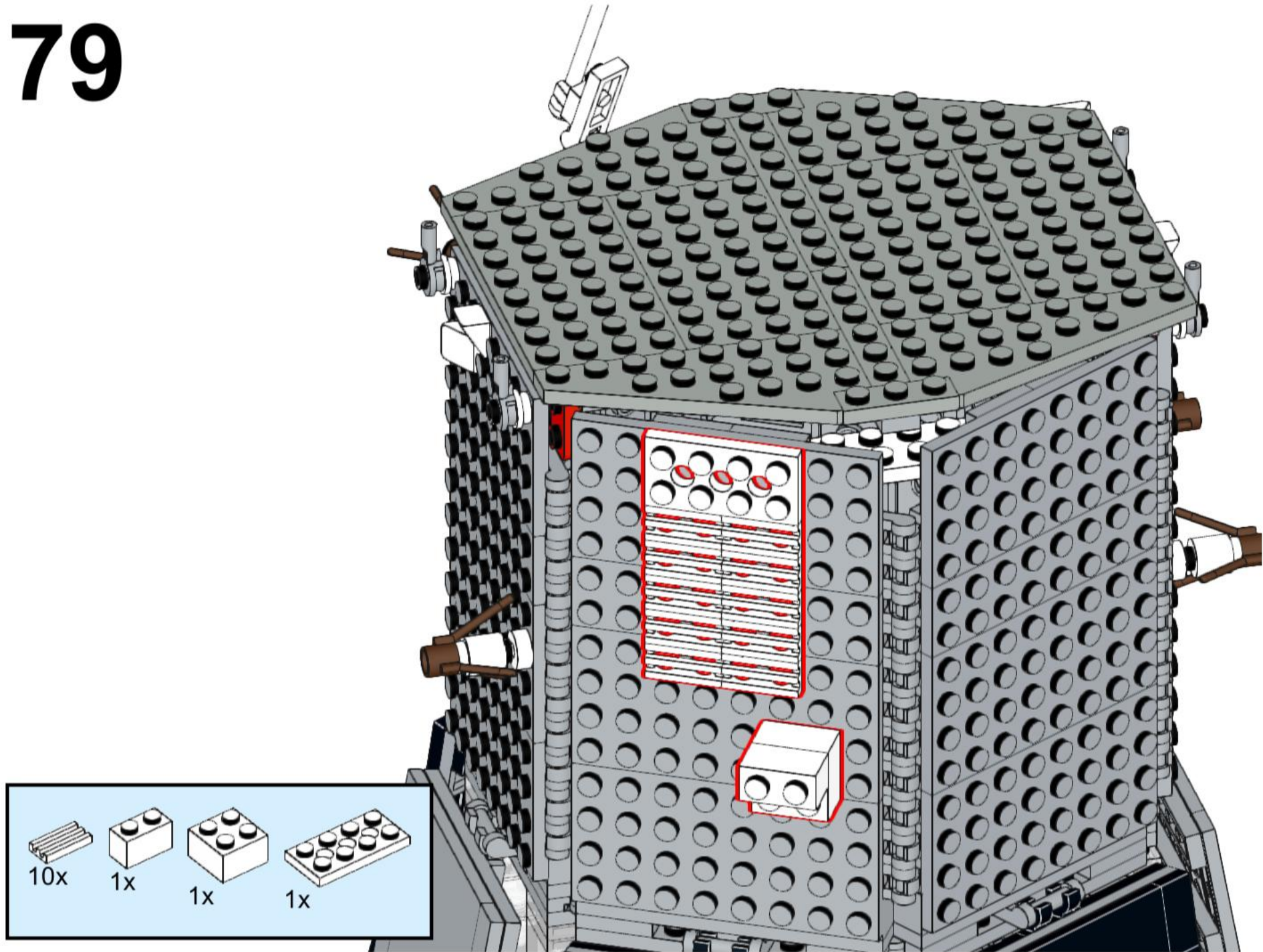

80

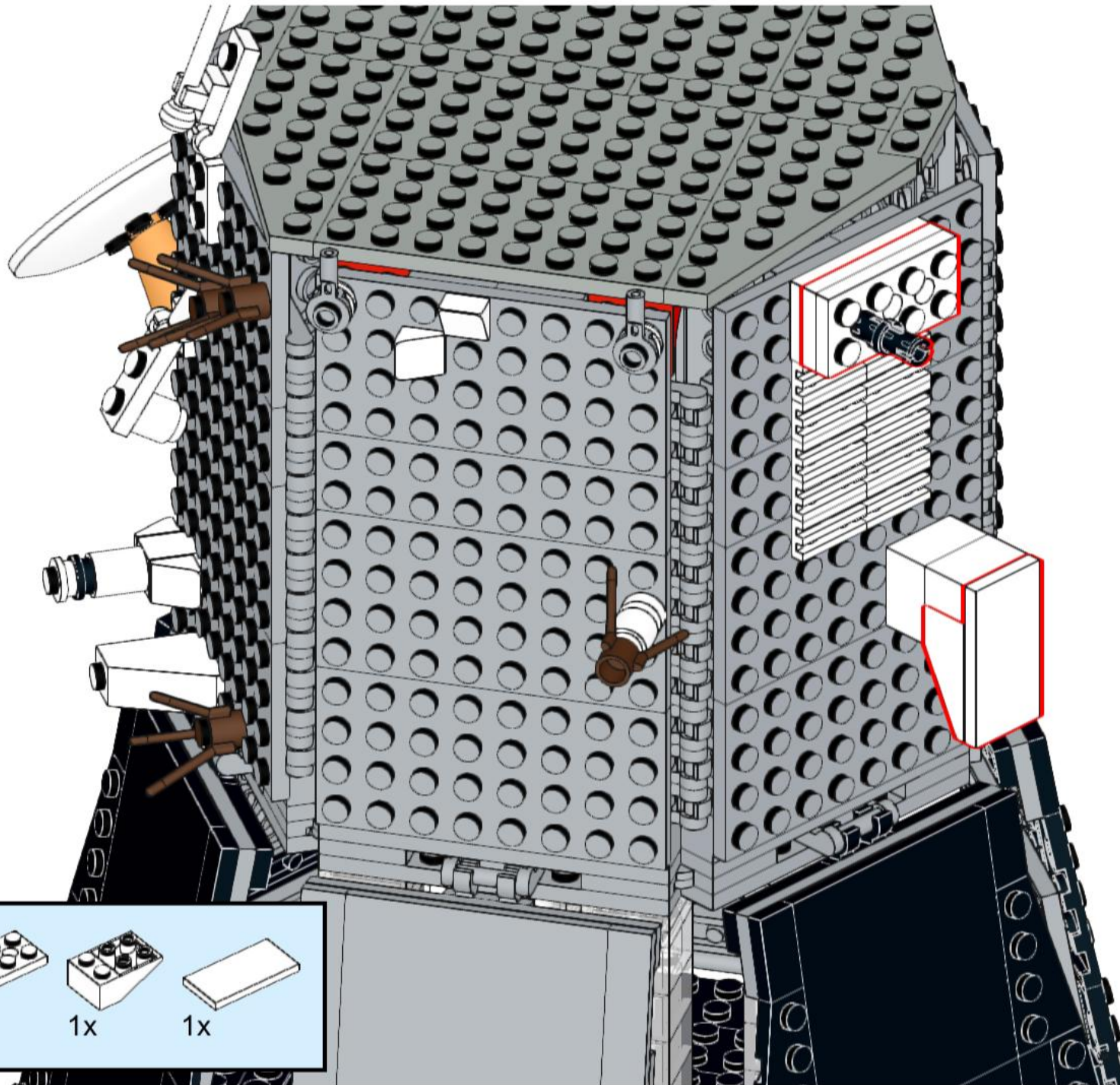

81

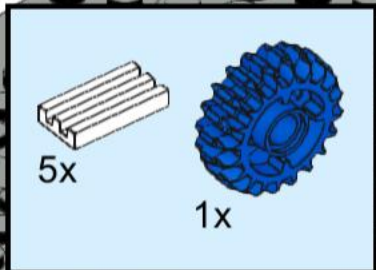

5x

1x

This inset box shows the parts required for step 81: five white Technic axles and one blue Technic gear.

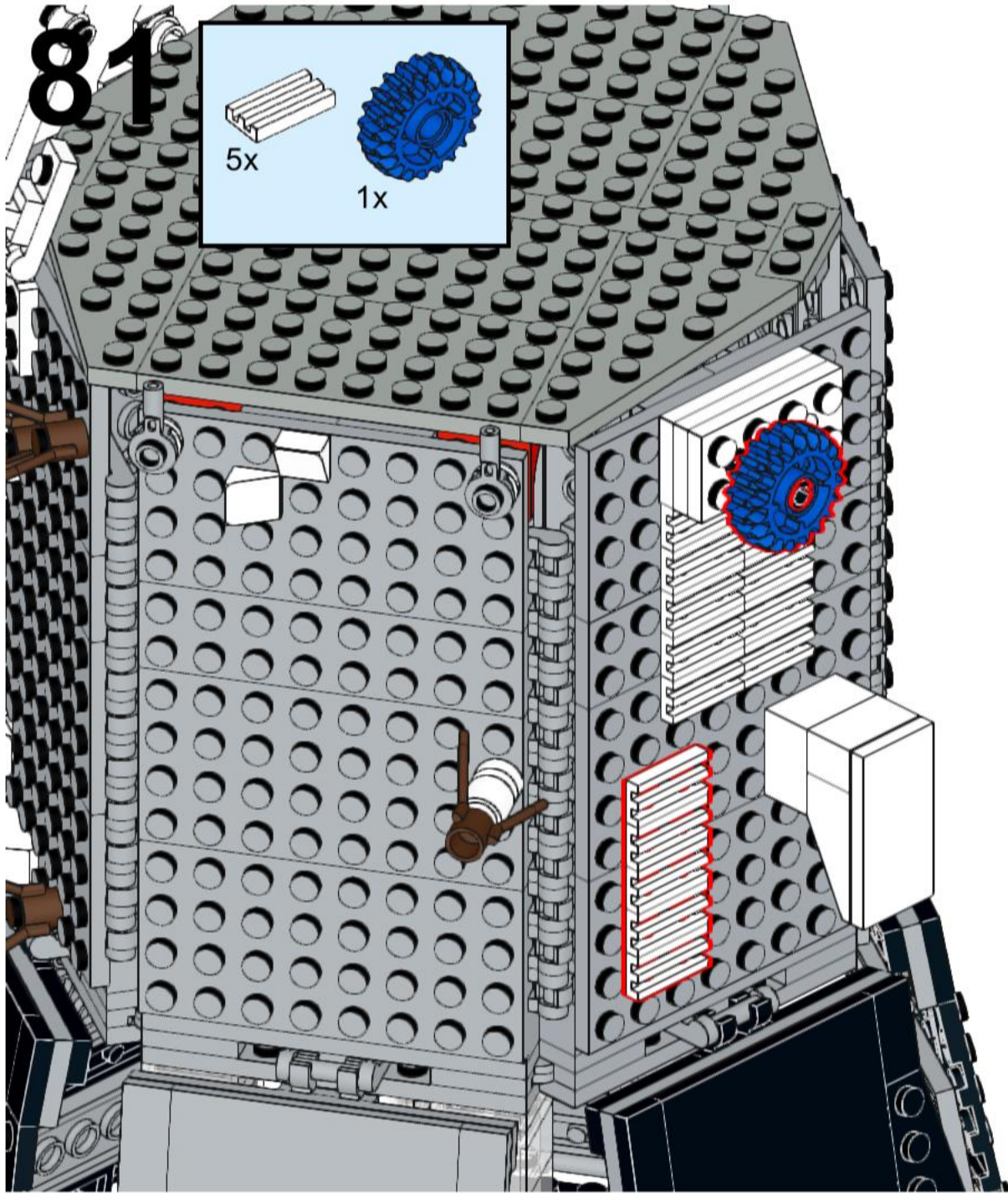

82

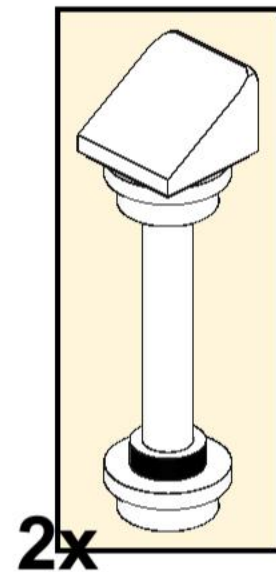
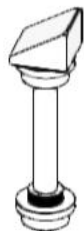
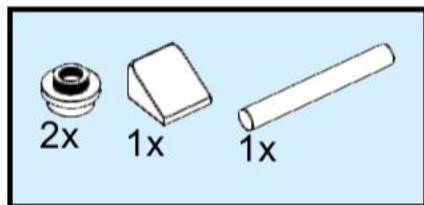

83

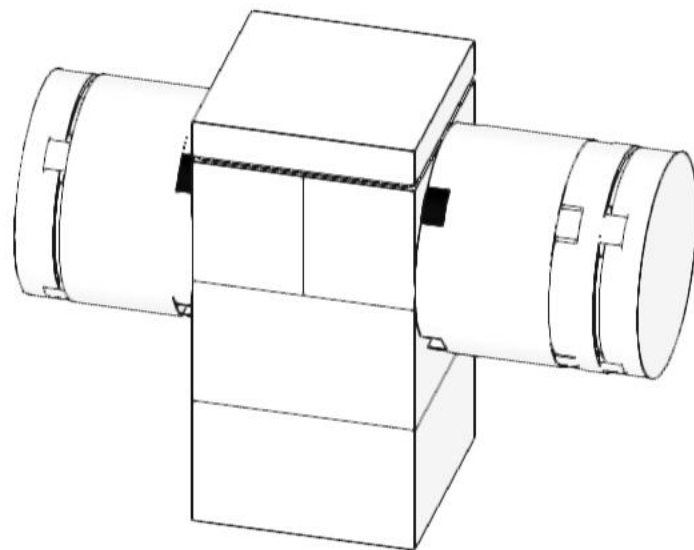
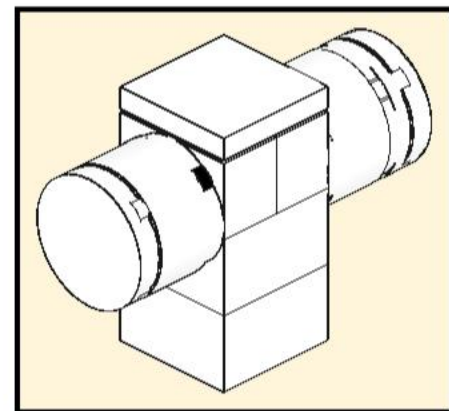
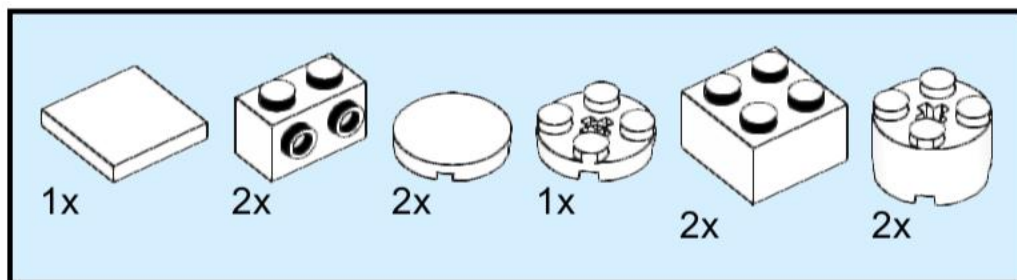



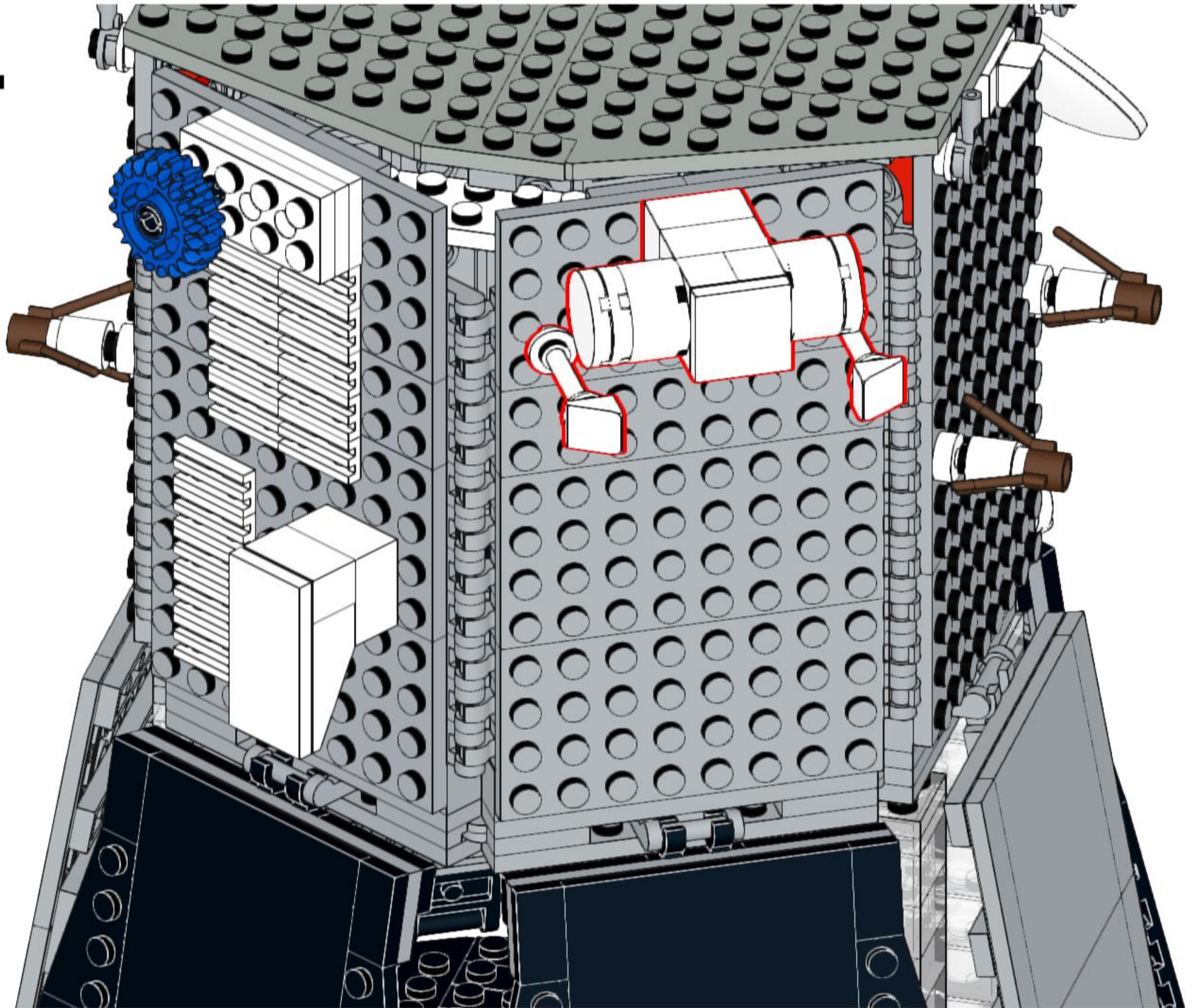

84

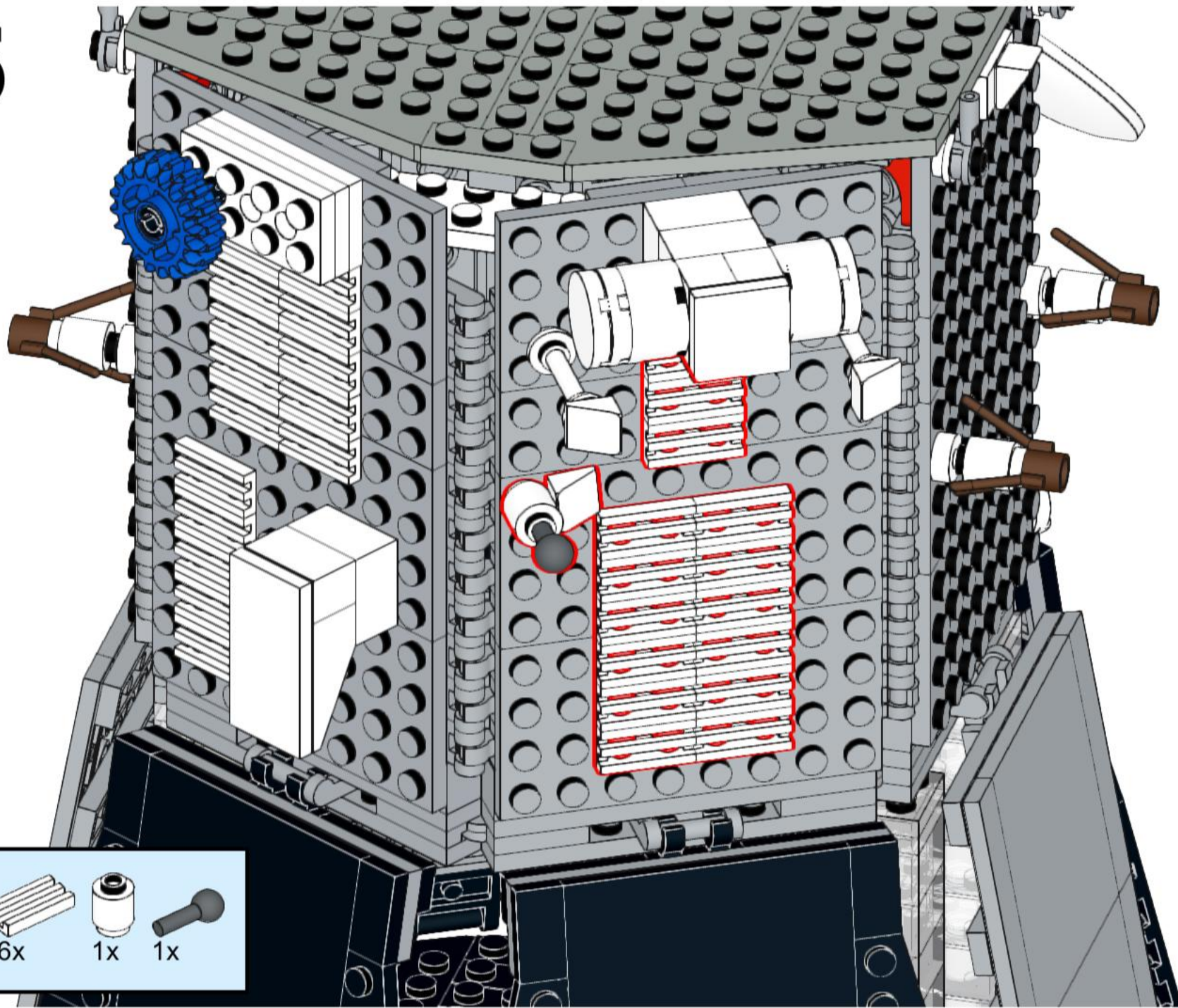

85



			
1x	16x	1x	1x

86

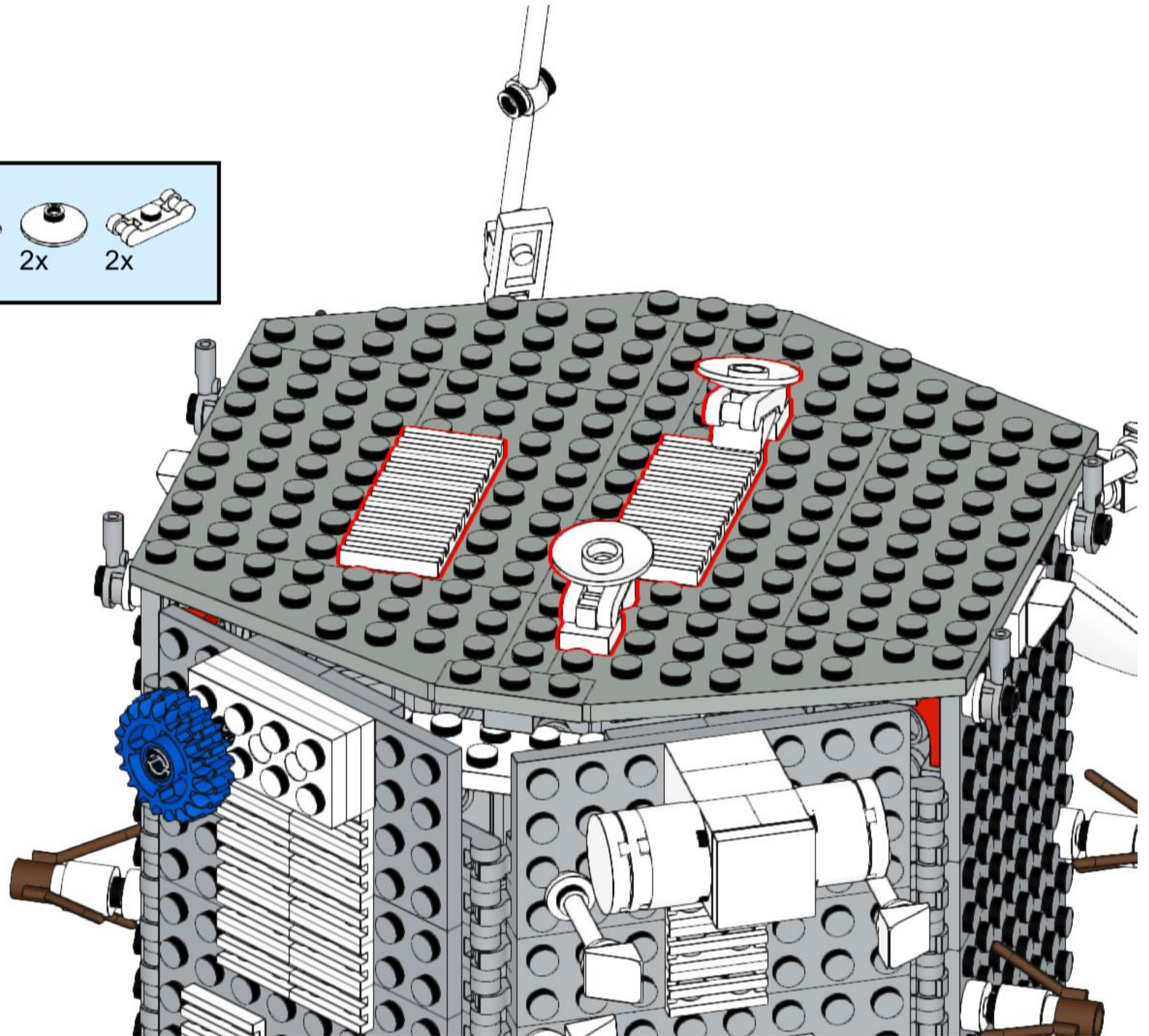
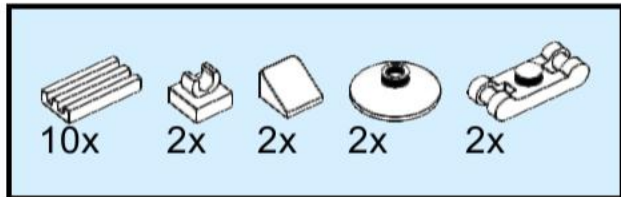

87

